

Epson® PowerLite® 62c/82c Multimedia Projector



User's Guide

Important Safety Information

WARNING: Never look into the projector lens when the lamp is turned on; the bright light can damage your eyes. Never let children look into the lens when it is on. Never open any cover on the projector, except the lamp and filter covers. Dangerous electrical voltages inside the projector can severely injure you. Except as specifically explained in this *User's Guide*, do not attempt to service this product yourself. Refer all servicing to qualified service personnel.

WARNING: The projector and its accessories come packaged in plastic bags. Keep plastic bags away from small children to avoid any risk of suffocation.

Caution: When you replace the lamp, never touch the new lamp with your bare hands; the invisible residue left by the oil on your hands may shorten the lamp life. Use a cloth or glove to handle the new lamp.

Copyright Notice

All rights reserved. No part of this publication may be reproduced, stored in a retrieval system, or transmitted in any form or by any means, electronic, mechanical, photocopying, recording, or otherwise, without the prior written permission of Seiko Epson Corporation. The information contained herein is designed only for use with this Epson product. Epson is not responsible for any use of this information as applied to other products.

Neither Seiko Epson Corporation nor its affiliates shall be liable to the purchaser of this product or third parties for damages, losses, costs, or expenses incurred by purchaser or third parties as a result of: accident, misuse, or abuse of this product or unauthorized modifications, repairs, or alterations to this product, or (excluding the U.S.) failure to strictly comply with Seiko Epson Corporation's operating and maintenance instructions.

Seiko Epson Corporation shall not be liable for any damages or problems arising from the use of any options or any consumable products other than those designated as Original Epson Products or Epson Approved Products by Seiko Epson Corporation.

Trademarks

Epson is a registered trademark, and Exceed Your Vision and Instant Off are trademarks of Seiko Epson Corporation.

PowerLite, PrivateLine, and Presenters Club are registered trademarks; SizeWise is a trademark; and Epson Store and Extra Care are service marks of Epson America, Inc.

Pixelworks, DNX, and the DNX logo are trademarks of Pixelworks, Inc.

General Notice: Other product names used herein are for identification purposes only and may be trademarks of their respective owners. Epson disclaims any and all rights in those marks.

C

Contents

<i>Welcome</i>	7
Getting the Most from Your Projector	8
Using Your Documentation	9
Getting More Information	9
Registration and Warranty	10
Unpacking the Projector	10
Projector Parts	11
Additional Components	12
Optional Accessories	13

1

<i>Setting Up the Projector</i>	15
Positioning the Projector	16
Other Installations	17
Connecting to a Computer	18
Connecting with the VGA Cable	19
Connecting with a VGA-5BNC Cable	20
Connecting a USB Cable for Remote Mouse Control ..	21
Connecting an External Monitor	22
Playing Sound Through the Projector	23
Connecting to Video Sources	24
Connecting a Composite Video Source	25
Connecting an S-Video Source	26
Connecting an RGB Video Source	27
Connecting a Component Video Source	28
Playing Sound Through the Projector	29

2

<i>Projecting</i>	31
Turning On Your Equipment	32
Turning On the Projector	32
Selecting the Image Source	34
What To Do If You See a Blank Screen	34
Adjusting the Image	37
Focusing and Zooming Your Image	38
Adjusting the Height of Your Image	38
Adjusting the Image Shape	39
Adjusting the Brightness	40
Correcting Computer Images	40
Adjusting the Color Mode	41
Adjusting the Volume	42
Shutting Down the Projector	42

3

<i>Using the Remote Control</i>	45
Controlling the Picture and Sound	46
Switching Between Picture Sources	46
Turning Off the Picture and Sound	47
Stopping Action	47
Zooming Your Image	47
Changing the Image's Aspect Ratio	48
Using the Remote Control as a Wireless Mouse	49
Replacing the Batteries	50

4

<i>Fine-tuning the Projector</i>	51
Using the Projector's Menu System	52
Changing Menu Settings	53
Adjusting Colors and Clarity	55
Adjusting the Input Signal	58
Customizing Projector Features	60
Selecting Projector Setup Options	62

Viewing Lamp Usage and Other Information	64
Using the Projector's Security Features.	65
Creating Your Own Screen Logo.	66
Setting a Password	68
Turning On the Password and User's Logo	68
Starting the Projector with a Password.	69
Disabling the Projector's Buttons	70
Restoring the Default Settings	71

5

Maintaining and Transporting

<i>the Projector</i>	73
Cleaning the Lens	74
Cleaning the Projector Case.	74
Cleaning and Replacing the Air Filter	75
Replacing the Lamp	77
Resetting the Lamp Timer	79
Transporting the Projector.	80

6

Solving Problems

.	81
Using On-Screen Help.	82
What To Do When the Lights Flash	83
Solving Problems with the Image or Sound	85
Solving Password Problems	93
Solving Problems with the Remote Control.	93
Where To Get Help.	95
Telephone Support Services.	95

A

<i>Technical Specifications</i>	97
General	97
Projection Lamp	98
Remote Control	98
Mouse Compatibility	98
Dimensions	98
Electrical	98
Environmental	99
Safety and Approvals	99
Compatible Video Formats	100
Compatible Computer Display Formats	101

B

<i>Notices</i>	103
Important Safety Instructions	103
Remote Control Information	105
FCC Compliance Statement	106
 <i>Index</i>	 107

W

Welcome

The Epson® PowerLite® 62c and 82c are ultra-portable projectors that offer 2000 ANSI lumens of brightness. From classrooms to auditoriums, your full-color presentations and videos will be bright and visible even in ordinary indoor lighting. Additionally, the projector's built-in amplifier and speaker deliver powerful 5 watt audio, making it perfect for presentations in large rooms.

Images are displayed at a native resolution of 800 × 600 pixels (PowerLite 62c) or 1024 × 768 pixels (PowerLite 82c). Epson 3LCD technology ensures accurate color and remarkable saturation, even in well-lit rooms. Support for S-Video contributes to theater-quality performance.

You can connect the projector to a wide range of computers, including IBM®-compatible PCs and laptops, Apple® Macintosh®, Power Macintosh® series (including G3, G4, and G5 systems), PowerBook® computers, and many iMac® and iBook® series systems. With Epson's patented SizeWise™ technology, the projector supports computer displays ranging from VGA through UXGA.

You can use any of the following video sources: HDTV, VCR, DVD player, gaming console (such as Microsoft® Xbox™, Sony® PlayStation® 2, and Nintendo GameCube™), camcorder, digital camera, or laser disc player. The projector supports NTSC, PAL, and SECAM video formats.

You can connect up to four devices to the projector at the same time. The source buttons let you easily switch among them, and a dedicated audio port for each source lets you switch sound as well as video. With the projector's **Source Search** button, you don't even have to identify your input source. Just press the button until you see the image you want on the screen.

To prevent unauthorized use of the projector, you can assign a password, create a user logo which is displayed at startup to identify the projector, and disable the projector's buttons through the Operation Lock feature. For more information about security features, see page 65.

Getting the Most from Your Projector

Depending on your presentation, you can take advantage of any or all of these options:

- **Connecting to a laptop or other computer**

If you want to connect the projector to a laptop or desktop computer, see page 18. For additional presentation control, you can connect a USB cable to the projector for running slide shows, and connect an external monitor to view the presentation on your computer simultaneously.

- **Connecting to video sources**

You can connect a DVD player, VCR, HDTV, camcorder, laser disc player, digital camera, and other video sources to your projector. See page 24 for instructions.

- **Using the remote control**

The remote control lets you switch from computer to video sources, zoom in on part of your image, freeze or mute the presentation, and adjust many other projector features. For details, see Chapter 3.

By connecting a USB cable to your projector, you can also use the remote control as a wireless mouse. This lets you click through computer-based presentations (such as PowerPoint®) from up to 20 feet away. For more information, see page 49.

Using Your Documentation

Your documentation includes a *Quick Setup* sheet, warranty brochures, and an Epson PrivateLine® Support card.

The *Quick Setup* sheet gives instructions to quickly set up your projector and connect it to a computer or video device.

This book contains all the information you need to set up and use your projector. Please follow these guidelines as you read through it:

- **Warnings** must be followed carefully to avoid bodily injury.
- **Cautions** must be observed to avoid damage to your equipment.
- **Notes** contain important information about your projector.

Getting More Information

Need tips on giving presentations? How about quick steps for setting up your projector? Here's where you can look for help:

- **www.presentersonline.com**
Includes a library of articles covering presentation tips, tricks, and technology. The site provides templates, clip art, and sound clips, as well as Presenters Services to use on the road. Even more resources and services are available if you register to join the Presenters Club®—and it's free.
- **Built-in help system**
Press the **Help** button on the remote control or projector to get quick solutions for common problems. See page 82 for details.
- **support.epson.com**
Download FAQs (frequently asked questions) and e-mail your questions to Epson support.

If you still need help after checking this *User's Guide* and the sources listed above, you can use the Epson PrivateLine Support service to get help fast. Call (800) 637-7661 and enter the PIN on your PrivateLine Support card. See page 95 for more information.

Registration and Warranty

Your projector comes with a basic carry-in warranty and an international warranty that let you project with confidence anywhere in the world. For details, see the warranty brochures that came with your projector.

In addition, Epson offers free Extra CareSM Road Service. In the unlikely event of an equipment failure, you won't have to wait for your unit to be repaired. Instead, Epson will ship you a replacement unit anywhere in the United States or Canada, usually via overnight delivery. See the Extra Care Road Service brochure for details.

To register, complete the registration form that came with your projector and mail it to Epson. Or register your product online at:

<http://www.epson.com/webreg>

Registering also lets you receive special updates on new accessories, products, and services.

Unpacking the Projector

After unpacking the projector, make sure you have all these items:

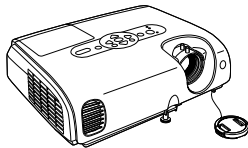

Projector

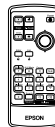

Remote control
and batteries

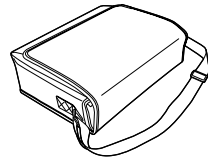

Soft carrying case

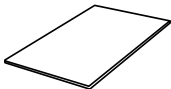

Quick Setup sheet

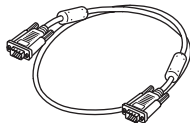

VGA computer cable



Power cord



Password Protected
Sticker

Save all packaging in case you need to ship the projector. Always use the original packaging (or equivalent) when you need to send the projector to another location.

If you are moving the projector by hand, use the carrying case included with the projector.

Projector Parts

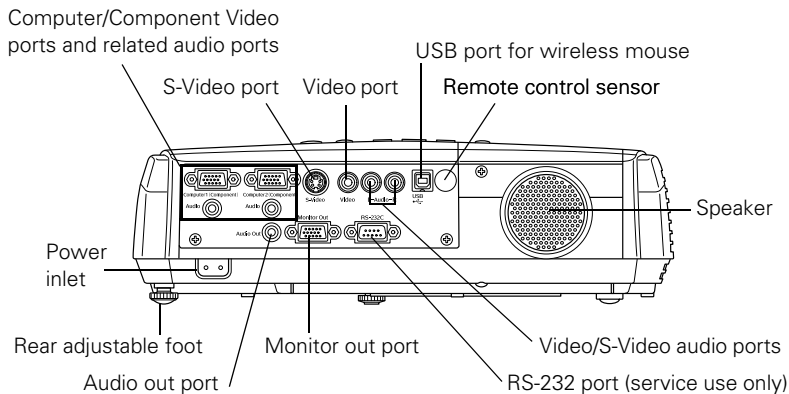
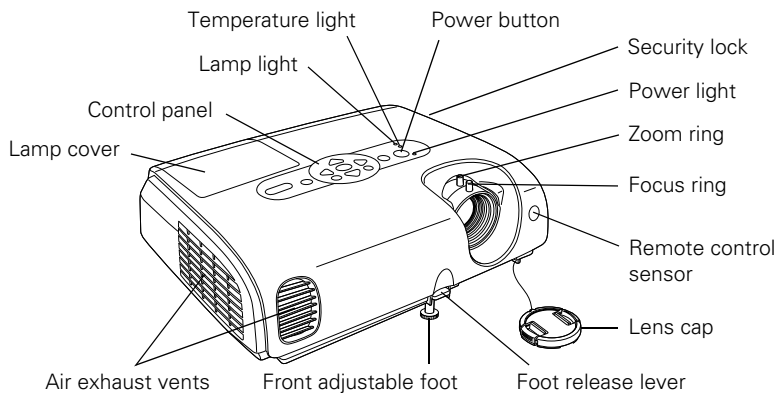

Additional Components

Depending on how you plan to use the projector, you may need additional components:

- To receive an S-Video signal, you need an S-Video cable. One is usually provided with your video device, or you can purchase it from Epson. See page 13.
- To receive a component video signal from a VCR or other video device, you need a D-sub, 15-pin, VGA-to-component video cable, which is available from Epson. See page 13.
- Some older PowerBooks and Macintosh desktop models may need a Macintosh video adapter; see your computer dealer. Older iMac systems may need a special adapter to provide a VGA output port; see your computer dealer.
- To receive an audio signal, you need a commercially available audio adapter; see your computer or electronics dealer.
- To use the projector's remote control as a wireless mouse, you need a USB cable; see your computer or electronics dealer.

Optional Accessories

To enhance your use of the projector, Epson provides the following optional accessories:

Product	Product number
Replacement lamp	V13H010L34
Air filter set (includes 2 filters)	V13H134A08
Samsonite® wheeled soft case for projector and laptop	ELPKS35-S
Samsonite soft shoulder case with laptop compartment	ELPKS43
Component video cable S-Video cable	ELPKC19 ELPSV01
Distribution amplifier	ELPDA01
50-inch portable screen 60-inch portable pop-up screen 80-inch portable pop-up screen 83.6-inch hanging pull-down screen	ELPSC06 ELPSC07 ELPSC08 ELPSC09
Image presentation camera ELPDC05	V12H162020
Kensington® security lock	ELPSL01
Ceiling mount (gyro lock with suspension adapter) False ceiling plate Suspension adapter Security bracket/cabling for gyro lock mounts Adjustable ceiling channel	ELPMBUNI ELPMBFCP ELPMBAPL ELPMBSEC ELPMBACC

You can purchase video cables, screens, carrying cases, or other accessories from an Epson authorized reseller. Please call 800-GO-EPSON (800-463-7766) for product information and to find the nearest authorized reseller. To purchase online, visit the Epson StoreSM at www.epsonstore.com (U.S. sales only). In Canada, please call (800) 463-7766 for dealer referral.

note

To purchase a replacement remote control, call (562) 276-4394 (U.S.) or (905) 709-3839 (for dealer referral in Canada).

1 *Setting Up the Projector*

This chapter tells you how to set up the projector and connect it to a computer or video source. You can connect up to four devices simultaneously: four video sources, one computer and three video sources, or two computers and two video sources.

You'll find instructions for the following in this chapter:

- Positioning the projector
- Connecting to a computer
- Connecting to video sources

Positioning the Projector

Before connecting the projector, you need to decide where to place it. If you're setting up the projector yourself and it isn't already installed in the room you're using, you'll probably want to place it on a table in front of the screen, as shown.

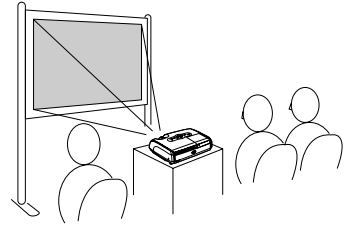

This lets you stand in the front of the room, face the audience, and remain close enough to the equipment to be able to control it. Try to leave as much space as possible between the projector and the screen to get a good-size image.

Place the projector somewhere between 3 and 35 feet from the screen. Use the figure below to help you determine exactly how far. Image size increases with distance, but can vary depending on how you've adjusted the optical zoom and other settings.

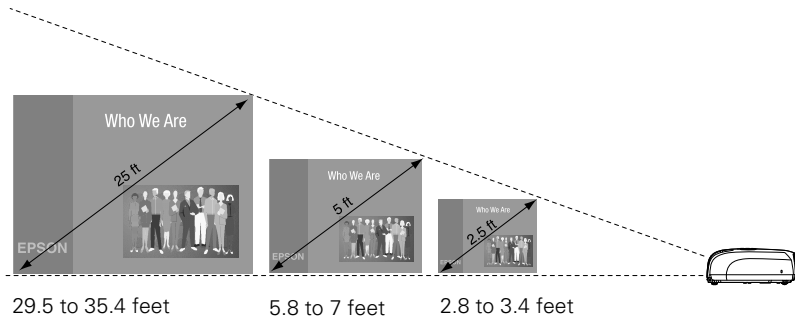

note

You can download the *Projection Distance Calculator* program from the *Drivers and Downloads* section of Epson's web site: <http://support.epson.com>.

Also keep these considerations in mind:

- Place the projector on a sturdy, level surface.
- Make sure there is plenty of space for ventilation around and under the projector. Do not set the projector on top of loose papers that could block the vents under the projector.
- Make sure the projector is within 6 feet (2 m) of a grounded electrical outlet or extension cord.

Try to place the projector directly in front of the center of the screen, facing it toward the screen squarely. If the projector isn't positioned this way, the image will be "keystone" shaped, instead of square or rectangular.

If you place the projector below the level of the screen, you'll have to tilt it up by extending the front adjustable foot, as described on page 38. This also causes the image to lose its rectangular shape, but the Auto Keystone feature corrects the distortion automatically. If the image does not regain its rectangular shape, the tilt angle is greater than 30° or the Auto Keystone feature may have been disabled. To turn it on, see page 61. To adjust it manually, see page 39.

note

The Auto Keystone feature corrects vertical distortion automatically. For more information, see page 39.

Other Installations

You can also project from behind the screen or from the ceiling, with the projector mounted upside-down:

Rear projection (using a translucent screen)

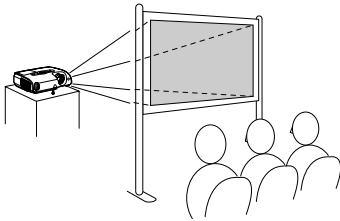

Rear/ceiling projection (using a translucent screen)

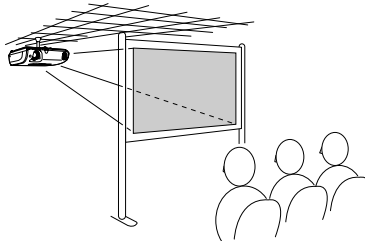

Front/ceiling projection

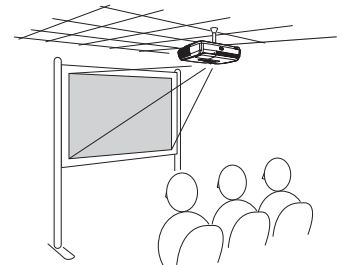

To project from overhead, you'll need the optional ceiling mount hardware. (See page 13 for ordering information.) You'll also need to select **Front/Ceiling** or **Rear/Ceiling** for the Projection option in the Extended menu. To project from the rear, select **Rear**. See page 62 for more information.

Connecting to a Computer

note

If you have an iBook with an RCA video-out port, follow the instructions for connecting to a video device on page 25.

You can connect the PowerLite projector to any computer that has a standard VGA or BNC monitor port, including PC notebook and laptop computers, Macintosh PowerBooks and iBooks, and hand-held devices. You can connect two computers at the same time.

Follow the instructions in this section to:

- Connect the projector to your computer with the VGA cable included with the projector.
- Connect the projector to your computer with a commercially available VGA–5BNC cable.

After connecting the projector to your computer, you may also want to:

- Connect a USB cable to your projector so that you can use the remote control as a wireless mouse; see page 21
- Connect a monitor to the projector so you can view your presentation close-up as well as on-screen (not necessary if you're using a laptop); see page 22
- Connect the projector to your computer with a commercially available audio adapter to play computer audio; see page 23

Connecting with the VGA Cable

Follow these instructions to connect to your computer with the VGA cable that came with your projector. Before you start, make sure your computer and the projector are turned off.

1. If you are connecting the projector to a desktop computer, disconnect the monitor cable from your computer.
2. Locate the VGA computer cable that came with the projector.

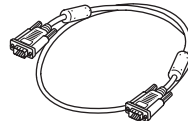

VGA computer cable

Connect one end of the cable to the projector's **Computer1(Component)** or **Computer2(Component)** port. If

you are going to connect your computer monitor to the projector for simultaneous display, use the **Computer1(Component)** port.

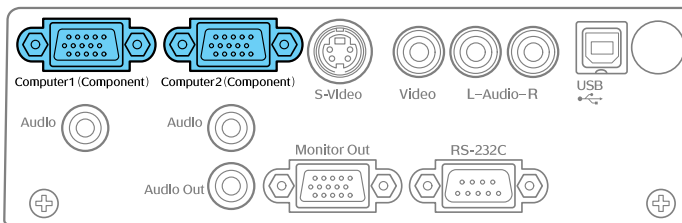

3. Connect the other end of the cable to your computer's video-out or monitor port.

If you're using a PowerBook or iBook and you can't connect the cable, you may need to use an optional Macintosh video adapter; see your computer dealer.

4. If you want to view the display simultaneously on your computer monitor and the projector screen, see "Connecting an External Monitor" on page 22.
5. Tighten the screws on the connectors.

If you don't need to make any other connections, you can plug in your projector and turn it on. See page 32 for instructions.

If more than one device is connected to the projector, select the correct source after projection starts by pressing the **Source Search** button on the projector or the **Comp1** or **Comp2** button on the remote control. See page 34.

Connecting with a VGA-5BNC Cable



VGA-5BNC cable

If your computer provides video output through BNC connectors, follow these instructions to connect the projector to your computer with an optional VGA-5BNC cable. Before you start, make sure your computer and the projector are turned off.

1. Disconnect the monitor cable from your computer.
2. Connect the cable's VGA connector to the projector's **Computer1(Component)** or **Computer2(Component)** port. If you are going to connect your computer monitor to the projector for simultaneous display, use the **Computer1(Component)** port.

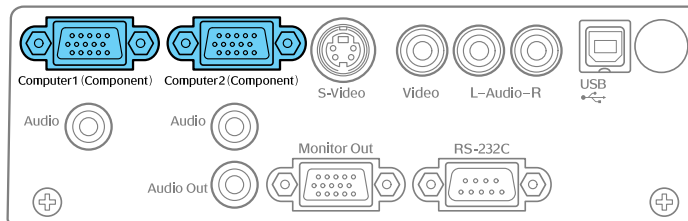

3. Connect the BNC connectors to your computer's BNC ports.
4. If you want to view the display simultaneously on your computer monitor and the projector screen, see "Connecting an External Monitor" on page 22.
5. Tighten the screws on the VGA connector.

If you don't need to make any other connections, you can plug in your projector and turn it on. See page 32 for instructions.

If more than one device is connected to the projector, select the correct source after projection starts by pressing the **Source Search** button on the projector or the **Comp1** or **Comp2** button on the remote control. See page 34.

Connecting a USB Cable for Remote Mouse Control

Using the remote control as a wireless mouse lets you click through slide show-style presentations, such as PowerPoint, from up to 20 feet away. This makes it easy to deliver your presentation, since you won't need to stand near your computer.

To use the wireless mouse function, you will need a USB cable, a system with a working USB port, and the full version of one of these operating systems:

Windows®	Macintosh
Windows 98SE, 2000, Me, or XP	Macintosh OS 9, OS X

1. If you are using a desktop computer, disconnect the mouse cable from your computer.
2. Connect the square end of the USB cable to the projector's  USB port.

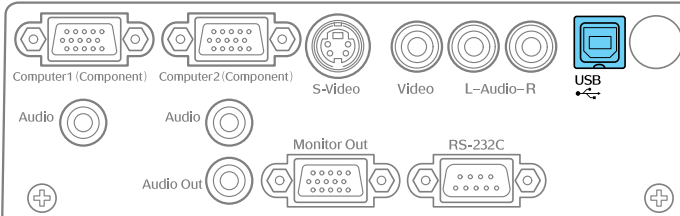

3. Connect the flat end of the cable to any available USB port on your computer.
4. If necessary, configure your laptop to work with an external mouse.

If you don't need to make any other connections, you can plug in your projector and turn it on. See page 32 for instructions.

note

For details about using the remote control as a wireless mouse, see page 49.

note

Some LCD monitors may not be able to display the image correctly. If you have trouble displaying the image, connect a multiscan monitor. If you're projecting computer images, make sure the computer's refresh rate is set to 65 Hz or greater.

Connecting an External Monitor

If you want to see your presentation close-up as well as on the projection screen, you can connect an external monitor to the projector. This lets you view images on your computer monitor while the projector is in standby mode (plugged in but not turned on) and check your presentation or switch between picture sources even if you've pressed the A/V Mute button on the remote control to turn off projection on the screen.

Simultaneous display is possible only when the computer is connected to the projector's **Computer1(Component)** port.

Make sure the projector and computer are off. Then connect the monitor's cable to the projector's **Monitor Out** port, as shown:

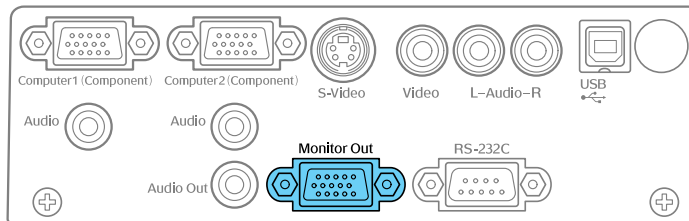



If you don't need to make any other connections, you can plug in your projector and turn it on. See page 32 for instructions.

Playing Sound Through the Projector

Your computer probably has its own sound system; however, it may not be adequate for your presentation. If you need more volume, you can connect a commercially available computer audio cable to take advantage of the projector's built-in amplifier and speaker. You can obtain a computer audio cable (3.5-mm stereo miniplug) from a computer or electronics dealer.

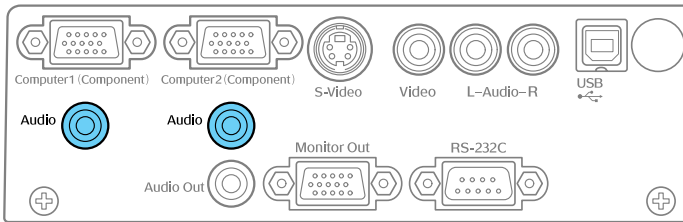
1. Connect one end of the audio cable to the corresponding Audio jack on the projector.



2. Connect the other end of the audio cable to your laptop's  headphone jack or  audio-out jack, or your desktop's speaker or audio-out port.

If you don't need to make any other connections, you can plug in your projector and turn it on. See page 32 for instructions.

note

*If you've connected two computers to the projector, you can play sound from both. Connect the audio cable for the computer connected to the **Computer2(Component)** connector to the corresponding **Audio jack** on the projector. Connect the other end of the cable to the second computer.*

Connecting to Video Sources

You can connect a DVD player, VCR, camcorder, laser disc player, digital camera, gaming console—such as Microsoft Xbox, Sony PlayStation 2, or Nintendo GameCube—or any other compatible video source to your projector. You can connect up to four video devices at one time.

note

The projector does not support TV antenna cable F connectors.

The projector supports HDTV, SDTV, NTSC, PAL, and SECAM, and automatically detects the video format. It can receive composite video, S-Video, RGB video, and component video. The type of cable you need depends on the video source:

- For composite video, use a commercially available RCA A/V cable. See page 25.
- For S-Video, use the S-Video cable supplied with your video device or order one from Epson. See page 26.
- For RGB video, use the VGA computer cable included with the projector. See page 27.
- For component video, you'll need the optional Epson component video cable. See page 28.

After connecting your video device to the projector, you may want to connect an audio cable to play sound from your video equipment through the projector's built-in speaker. See page 29 for instructions.

Connecting a Composite Video Source

If you're connecting a composite video device, use a commercially available RCA A/V cable. Before starting, make sure the projector and your DVD player or other video source are turned off.

1. Connect the yellow RCA plug on one end of the cable to the projector's yellow Video jack.

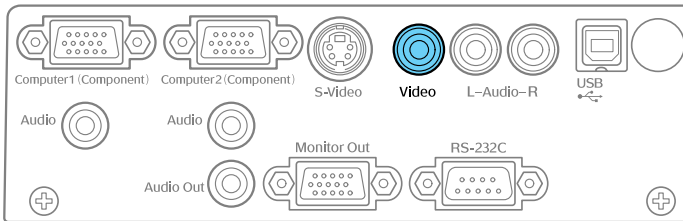

2. Connect the yellow plug on the other end of the cable to the video-out port on your video source.
3. To play sound through the projector, follow the instructions beginning on page 29.

If you don't need to make any other connections, you can plug in your projector and turn it on. See page 32 for instructions.

If more than one device is connected to the projector, select the correct source after projection starts by pressing the **Source Search** button on the projector or the **Video** button on the remote control. See page 34.

Connecting an S-Video Source

If your video source has an S-Video jack, you can use it to project a higher quality video image. You'll need an S-Video cable, which is usually provided with your video source, or you can purchase one from Epson (part number ELPSV01). See page 13 for ordering information.

Before starting, make sure the projector and your DVD player or other video source are turned off.

1. Insert one end of the S-Video cable into the projector's **S-Video** port and the other end into the S-Video output port of your video source.

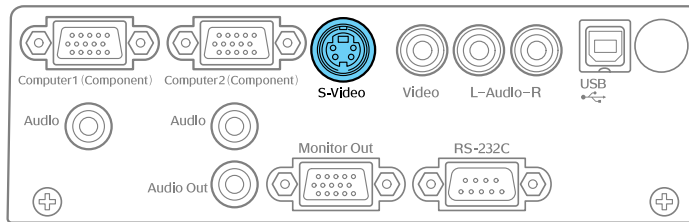

2. To play sound through the projector, follow the instructions beginning on page 29.

If you don't need to make any other connections, you can plug in your projector and turn it on. See page 32 for instructions.

If more than one device is connected to the projector, select the correct source after projection starts by pressing the **Source Search** button on the projector or the **S-Video** button on the remote control. See page 34.

Connecting an RGB Video Source

Follow these instructions to connect the projector to a video player or satellite receiver that has an RGB video output port using the VGA computer cable that came with the projector.

Before starting, make sure the projector and your DVD player or other video source are turned off.

1. Connect one end of the VGA computer cable to the **Computer1(Component)** or **Computer2(Component)** port on the projector.

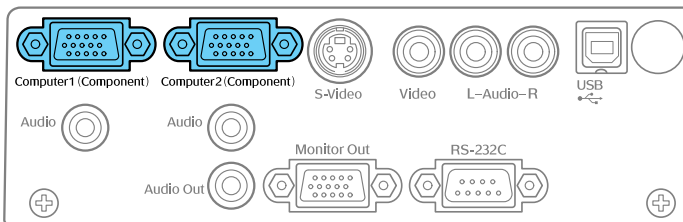

2. Connect the other end to the video port on your player.
3. To play sound through the projector, follow the instructions beginning on page 29.

If you don't need to make any other connections, you can plug in your projector and turn it on. See page 32 for instructions.

If more than one device is connected to the projector, select **Computer 1 (RGB)** or **Computer 2 (RGB)** as the source, depending on which port you used, after projection starts by pressing the **Source Search** button on the projector or the **Comp1** or **Comp2** button, depending on which port you used, on the remote control. See page 34.

Connecting a Component Video Source

If your video source has component video connectors, you can use them to project a higher quality video image. You'll need a component video cable, which can be purchased from Epson (part number ELPKC19). See page 13 for ordering information.

Before starting, make sure the projector and your DVD player or other video device are turned off.

1. Connect the large end of the component video cable to the projector's **Computer1(Component)** or **Computer2(Component)** port.

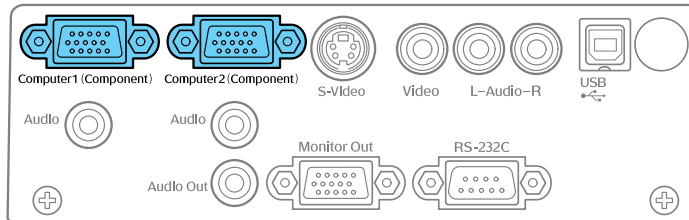

2. Insert the three ends of the component video cable into the **R**, **G**, and **B** ports on your video source.
3. To play sound through the projector, follow the instructions beginning on page 29.

If you don't need to make any other connections, you can plug in your projector and turn it on. See page 32 for instructions.

If more than one device is connected to your projector, select **Computer1 (Component Video)** or **Computer2 (Component Video)** as the source, depending on which port you used by pressing the Source Search button on the projector or the **Comp1** or **Comp2** button, depending on which port you used, on the remote control. See page 34.

Playing Sound Through the Projector

The projector has a built-in speaker with a maximum output of 5 W. You can play sound from your video equipment through the projector's speaker if your video device has an audio output port.

For RCA-Style Audio Output Ports

Most video devices have an RCA-style audio output port. In this case, use a commercially available audio adapter to connect the projector to your video source:

1. Connect the 3.5-mm stereo miniplug end of the audio adapter cable to the **Audio** jack corresponding to your video source. For example, if you've connected your video device to the projector's **Video** port, connect the adapter to the **Audio** jack next to it.

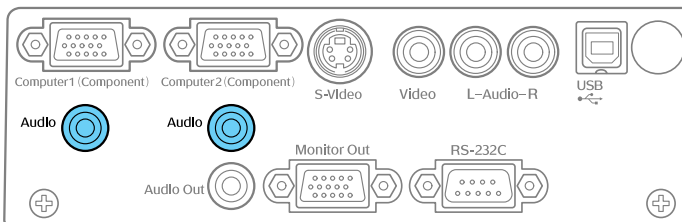

2. Connect the red and white plugs on the other end of the audio adapter cable to the corresponding color-coded audio output port on your video source.

If you don't need to make any other connections, you can plug in your projector and turn it on. See page 32 for instructions.

note

To play sound from a source, you must connect the audio cable to the correct audio jack.

When you switch the video source, the projector automatically plays sound from the new source.

For Stereo Mini-Jack Audio Output Ports

Some video devices, especially camcorders, may have a stereo mini-jack audio output port. In this case, use a commercially available stereo mini-jack audio cable to connect to the projector:

1. Connect one end of the audio cable to the **Audio** jack corresponding to your video source. For example, if you've connected your video device to the projector's **S-Video** port, connect the adapter to the **Audio** jack next to it.

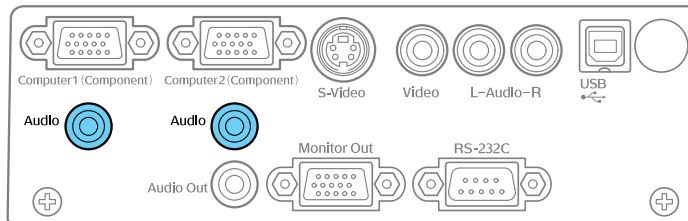

2. Connect the other end of the cable to your video device's audio output port.

If you don't need to make any other connections, you can plug in your projector and turn it on. See page 32 for instructions.

note

To play sound from a source, you must connect the audio cable to the correct audio output jack.

When you switch the video source, the projector automatically plays sound from the new source.

2 *Projecting*

Once you've set up the projector, you're ready to turn it on, adjust the image, and give your presentation.

Although you can operate the projector without it, the remote control lets you use additional features. See Chapter 3 for instructions on using the remote. This chapter covers the following:

- Turning on the projector and other equipment
- Adjusting the image
- Adjusting the volume
- Shutting down the projector

Turning On Your Equipment

Make sure your projector and other equipment are set up and connected correctly, as described in Chapter 1. Then turn on your projector, as described below.

If you turn on your connected computer or video equipment before starting the projector, the projector automatically detects and displays the image source. If you turn on the projector first, or have multiple pieces of connected equipment, you may have to select the image source manually. See page 34.

Turning On the Projector

Follow these steps to plug in and turn on the projector:

1. Push in the tabs and remove the lens cap.

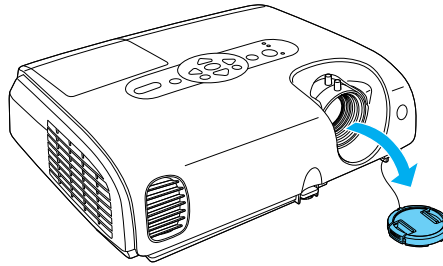

2. Connect one end of the power cord to the projector's power inlet.

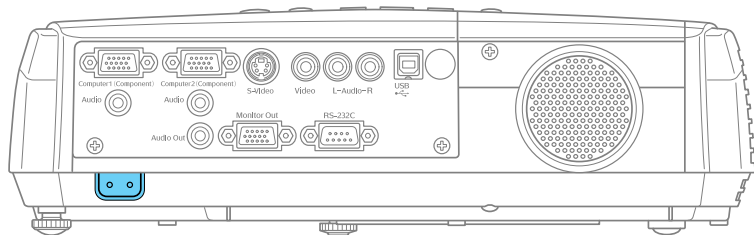

3. Connect the other end to an electrical outlet.

The power light on top of the projector turns orange, indicating that the projector is receiving power but not yet turned on. Wait until the light stops flashing but stays orange.

caution

Do not use the projector with the lens cap in place. The heat generated by the lamp can damage it.

4. Turn on your computer or video source if you have not already.
5. Press the **Power** button on top of the projector to turn it on. (You can also press the **Power** button on the remote control.)

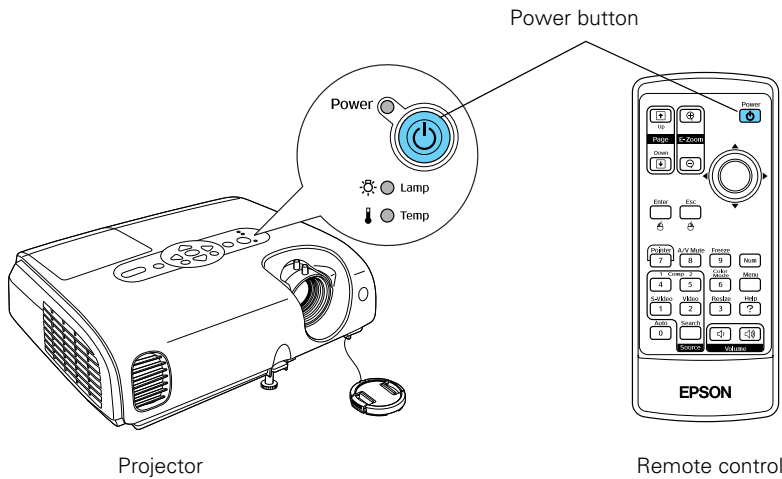

note

If you are using the remote control for the first time, be sure to insert the batteries as described on the Quick Setup poster.

The projector beeps and the power light flashes green as the projector warms up. The projector lamp comes on in about 4 seconds and the power light stays green.

- If you're using a computer, you should see your computer display projected after a moment or two. If not, you need to select the image source. See page 34.

(Windows only: If you see a message saying that it has found a plug-and-play monitor, click **Cancel**.)

- If you're projecting a video, press the **Source Search** button on the projector or remote control to switch to your video source. Then press the **Play** button on your DVD player or other device.
- If you are prompted to enter a password, see page 69.

To focus and adjust the image, see page 37. If a projected image fails to appear, see "What To Do If You See a Blank Screen" on page 34.

When you're done with your presentation, shut down the projector as described on page 42.

warning

Never look into the lens when the lamp is on. This can damage your eyes, and is especially dangerous for children.

note

The name of the selected image source appears in the upper right corner of the screen.

Selecting the Image Source

Selecting the image source lets you switch between images input from different pieces of equipment connected to the projector (such as a computer and DVD player). If you don't see the image you want, press one of the following buttons on the remote control:

- **Comp1**
Press this button to move through the following options: Computer1 (Auto), Computer 1 (RGB), and Computer 1 (Component Video).
- **Comp2**
Press this button to move through the following options: Computer 2 (Auto), Computer 2 (RGB), Computer 2 (Component Video).
- **S-Video**
Press to select S-Video.
- **Video**
Press to select Video.

You can also press the **Source Search** button on the remote control or projector until the correct device image is projected. If a projected image fails to appear, see the next section for help.

Once you see your image, turn to page 37 for instructions on focusing and making other image adjustments.

What To Do If You See a Blank Screen

If you see a blank screen or a blue screen with the message **No Signal** after turning on your computer or video source, try the following:

- Make sure the cables are connected correctly, as described in Chapter 1.
- Make sure the power light is green and not flashing and the lens cap is off.
- Make sure you've selected the correct image source; see the previous section. Allow a few seconds for the projector to sync up after pressing the button.

- Check the Signal menu to make sure the correct input source is selected. See page 58.

If you're using a PC laptop:

- Hold down the Fn key and press the function key that lets you display on an external monitor. It may have an icon such as  or it may be labelled CRT/LCD. Allow a few seconds for the projector to sync up after pressing it. Check your laptop's manual or online help for details.

On most systems, the  or CRT/LCD key lets you toggle between the LCD screen and the projector, or display on both at the same time.

- If you're projecting from a laptop, and you don't see the same image on the projection screen and computer screen, check your monitor settings to make sure both the LCD screen and the external monitor port are enabled.

From the Control Panel, open the **Display** utility. Click the **Settings** tab, then click **Advanced**. The method for adjusting the settings varies by brand; you may need to click a **Monitor** tab, then make sure the external Monitor port is set as your primary display and/or enabled. See your computer's documentation or online help for details.

If you're using a Macintosh laptop with OS X:

You may need to set up your system to display on the projector screen as well as the LCD screen. Follow these steps:

1. From the Apple menu, select **System Preferences**, then click **Display** or **Displays**.
2. Select **VGA Display** or **Color LCD**, click **Arrange** or **Arrangement**, and make sure **Mirror Displays** is checked.

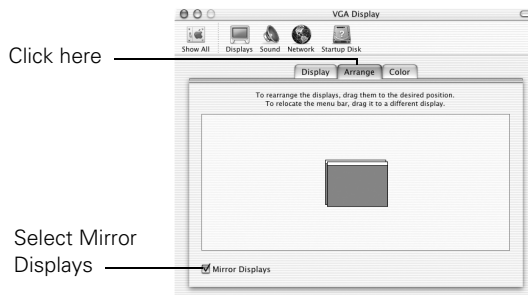

If you're using a Macintosh laptop with OS 9:

You may need to set up your system to display on the projector screen as well as the LCD screen. Follow these steps:

1. From the Apple menu, select **Control Panels**, then click **Monitors** or **Monitors and Sound**.
2. Click the **Arrange** icon.

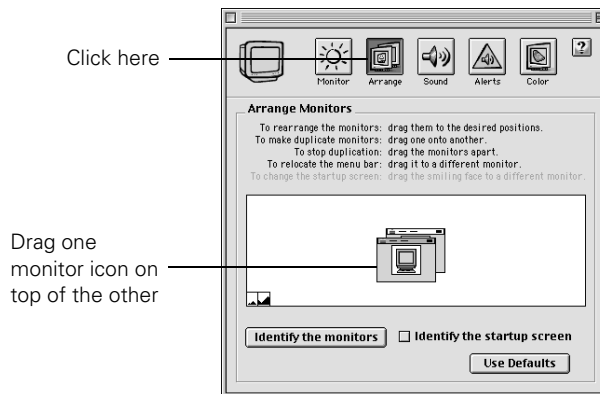

3. Drag one monitor icon on top of the other.

If the **Arrange** option isn't available, you may need to select one of the Simulscan resolution settings:

1. Click the **Monitor** icon, if necessary.

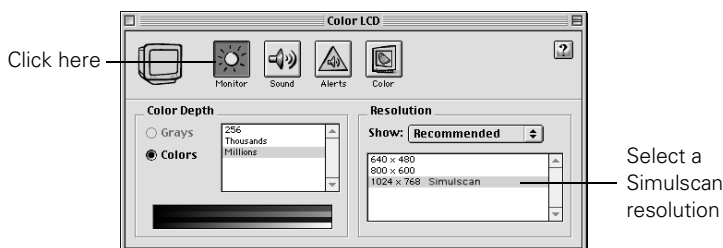

2. Select a **Simulscan** resolution, as shown. (Allow a few seconds for the projector to sync up after making the selection.)

Adjusting the Image

Once you see your image, you'll need to make certain adjustments:

- To focus or zoom your image, see page 38.
- If the image is too high or too low, you can reposition it. See page 38.
- If the image isn't square, see page 39.
- To adjust image brightness, see page 40.
- If a computer image displays incorrectly, see page 40.
- To change the color mode for your image and surroundings, see page 41.

You can make many other adjustments to the image—such as changing the brightness, contrast, and aspect ratio—using the projector's menu system. See Chapter 4 for more information.

Focusing and Zooming Your Image

Rotate the focus ring to sharpen the image.

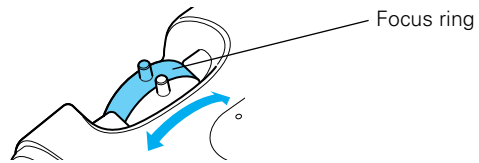

Rotate the zoom ring to reduce or enlarge the image.



You can also change the image size by moving the projector closer to or farther away from the screen. You can use the **E-Zoom** buttons on the remote control to zoom in on a portion of the image. See page 47 for instructions.

Adjusting the Height of Your Image

If the image is too low, you can raise it by extending the projector's front adjustable foot.

1. Stand behind the projector. Press up on the blue foot release lever and lift the front of the projector to extend the front adjustable foot.

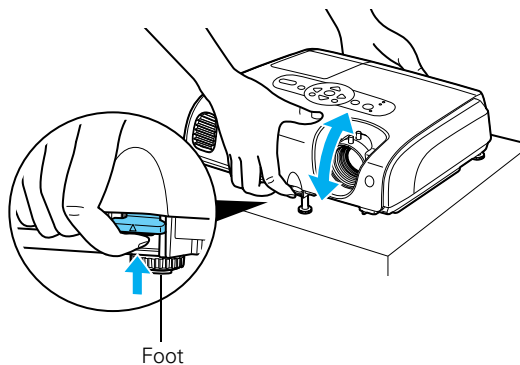



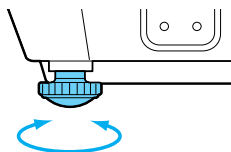



- Once the image is positioned where you want, release the lever to lock the foot in position.
- To fine-tune the height of the image, rotate the foot at the back of the projector.



If the image is no longer rectangular after raising it, see the next section.

Adjusting the Image Shape

The projector automatically corrects images that are distorted when the projector is tilted up or down (up to a 30° tilt). The Keystone window appears on the screen while the projector makes the correction. If the projected image still isn't rectangular or has a "keystone" shape, do one or more of the following:

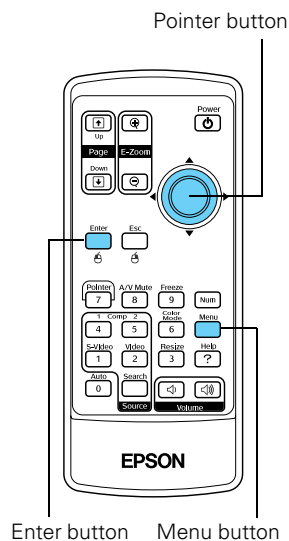

- If your image looks like  or , you've placed the projector off to one side of the screen, at an angle. Move it directly in front of the center of the screen, facing the screen squarely.
- If your image looks like  or , the Auto Keystone feature may have been disabled or you may need to manually adjust the keystone correction value. (Auto Keystone is not available when you're using ceiling or rear projection.) Follow the directions below:
 - To turn on Auto Keystone, press the **Menu** button on the remote control. Use the  pointer button on the remote control (or the arrow buttons on the projector) to select the **Settings** menu, then press **Enter**. If Auto Keystone is **OFF**, use the  pointer button to highlight this option and press **Enter**. Select **ON** in the Auto Keystone window that appears and press **Enter** to save your changes. Exit the menu by pressing the **Menu** button.

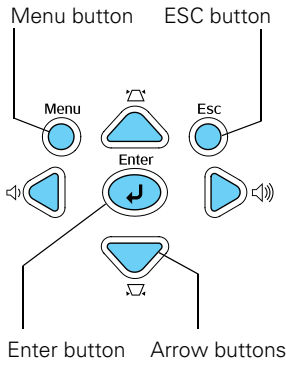

note

You can also use the buttons on the projector to access the menu system:



- To manually adjust the keystone correction value, press the  or  buttons on the projector to correct the shape of the image. After correction, your image will be slightly smaller.

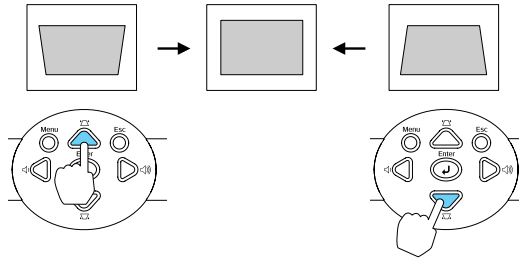

You can also make keystone adjustments using the projector's Settings menu. See page 61.

Adjusting the Brightness

The brightness of an image depends on the source you are projecting and the amount of light in the room. If the image is too bright or not bright enough, here are two ways you can adjust it:

- Change the **Brightness** setting in the Image menu. See page 56.
- Select **Low** or **High** for the **Brightness Control** option in the Settings menu. (See page 61.) Low brightness mode extends the life of the lamp and decreases the fan noise.

Correcting Computer Images

If you've connected a computer and the image doesn't look right, or it doesn't fit properly on the screen, press the **Auto** button on the remote control. This automatically resets the projector's tracking, sync, resolution, and position settings. You must be projecting a computer image for this button to have any effect. Additionally, if the **Auto Setup** option in the Signal menu is set to **OFF**, the Auto function will not work. See page 59.

Adjusting the Color Mode

You may want to adjust the color mode to select a different setting that is appropriate for the image you're projecting and the environment in which you're projecting it.

If you're projecting computer or RGB video images, the default color mode is **Presentation**, which is appropriate for presentations in bright rooms.

The following table lists the color modes available.

Color mode	Description
Photo	Best for projecting still images with vivid color in a bright room (Computer input only).
Sports	Best for watching TV in a bright room (component, S-video, or composite video input only).
Presentation	Use when you're projecting a presentation in a bright room.
Theatre	Use when projecting movies in a dark room.
Game	Best for playing video games in a bright room.
sRGB	Use when projecting computer images conforming to the sRGB color standard.
Blackboard	Choose this fixed color mode when you need to project against a green blackboard.

To change the color mode, press the **Color Mode** button on the remote control until you see the mode you want. The currently selected setting appears in the upper right corner of the screen. You can also use the projector menu system to change the color mode in the Image menu (see page 56).

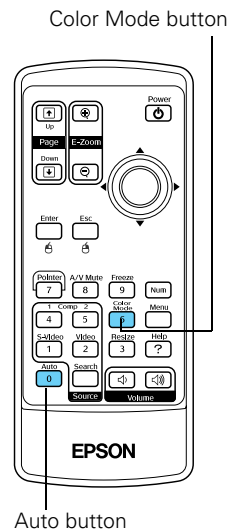



Adjusting the Volume

note

You can also adjust the volume using the projector's Settings menu. See page 60 for details.

You must adjust the volume separately for each input source.

You can use the buttons on the remote control or projector to increase or decrease the volume for both the projector's built-in speaker and external speakers connected to the projector. Press the  button to increase the volume, or the  button to decrease it. A volume gauge appears on the screen while the volume is being adjusted.

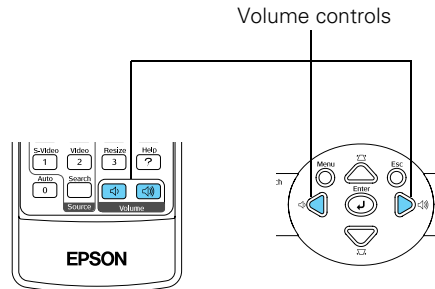

note

When the projector has not received any input signals for 30 minutes, it automatically turns off the projector lamp and enters "sleep mode." This conserves electricity, cools the projector, and extends the life of the lamp. If you are done using the projector, unplug the power cord. If you want to start projecting again, press the  Power button. You can turn sleep mode on or off through the Extended menu. See page 63.

Shutting Down the Projector

When you've finished using the projector, follow the recommended procedure to shut it down.

1. If you're using a computer, shut it down first; otherwise you may not be able to see your computer's display to shut it down properly.
2. To turn off the projector, press the  Power button on the projector or remote control.

You see this confirmation message:
(If you don't want to turn it off, press any other button or wait a few seconds until it disappears.)

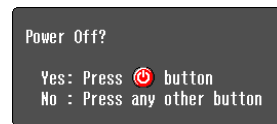

3. Press the  Power button again. The projector beeps twice, the lamp is turned off, and the power light turns orange.

With Epson's exclusive Instant Off™ technology there's no cool-down period, so you can pack up and go immediately after turning off the projector.

If you want to turn the projector on again, press the  Power button.

4. Press up on the blue foot release lever and lower the projector to retract the front adjustable foot, as shown.

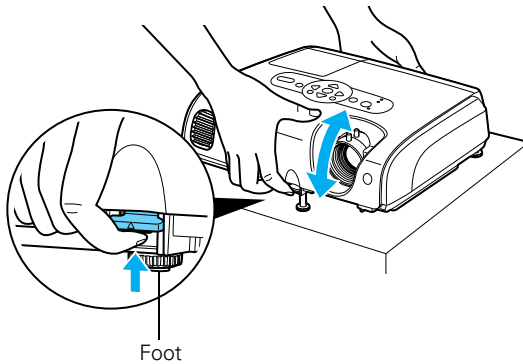

5. Replace the lens cap and unplug the power cord.
6. Turn off and disconnect any equipment plugged into the projector.
7. If you won't be using the projector for awhile, store it in the soft case that came with it or in a protective case.

caution

To avoid damaging the projector or lamp, never unplug the power cord when the power light is green or flashing orange.

3 *Using the Remote Control*

The remote control lets you access your projector's features from anywhere in the room—up to 20 feet away. For example, you can turn the projector on and off, freeze the presentation, zoom in on a portion of your image, and access the menu system. (The projector menus let you adjust many projector settings; see Chapter 4.)

If you're using a computer and you've connected a USB cable as described in Chapter 1, you can use the remote control as a wireless mouse.

When using the remote control, stand within 20 feet of the projector. Point the remote control either at the front or back of the projector or at the screen (the projector's front sensor can detect signals bounced off the screen). Press the button for the function you want to use.

This chapter covers the following information:

- Controlling the picture and sound
- Using the remote control as a wireless mouse
- Replacing the remote control batteries

Controlling the Picture and Sound

You can use the remote control to select your source, temporarily turn off the picture and sound, freeze the action, or zoom in on the picture. Make sure you have set up your projector and connected any equipment as described in Chapter 1.

Switching Between Picture Sources

If you've connected your projector to more than one computer and/or video source, you can use the buttons on the remote control to switch between the different sources.

- Press the **Comp1** button to select the computer or video source connected to the projector's **Computer1(Component)** port.
- Press the **Comp2** button to select the computer or video source connected to the projector's **Computer2(Component)** port.
- Press the **S-Video** button to select a video source connected to the projector's **S-Video** port.
- Press the **Video** button to select a video source connected to the projector's **Video** port.
- Press the **Source Search** button to move successively through all of the input sources.

Select a source

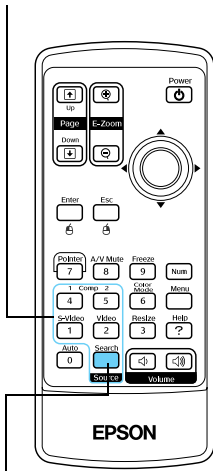

Moves through all the input sources in sequence

After you select a source, the screen goes dark for a moment before the image appears. The name of the selected source (such as **Computer1** or **S-Video**) appears briefly on the screen.

Turning Off the Picture and Sound

Press the **A/V Mute** button on the remote control to turn off the image and sound and darken your screen. This is useful if you want to temporarily re-direct your audience's attention without the distraction of a bright screen.

- To turn off the picture and sound, press the **A/V Mute** button. The screen goes dark.
- To turn the image and sound back on, press the button again, or press **Esc**.

You can create an image, such as a company logo or a picture, to display on the screen whenever you press the **A/V Mute** button. See page 66 for more information.



Stopping Action

Press the **Freeze** button to stop the action in your video or computer image and keep the current image on the screen. The sound will continue, however. Also, because the source continues to transmit signals, you won't resume the action from the point you paused it.



Press the **Freeze** button again or press **Esc** to restart it.

Zooming Your Image

Follow these steps to zoom in on a portion of the image:

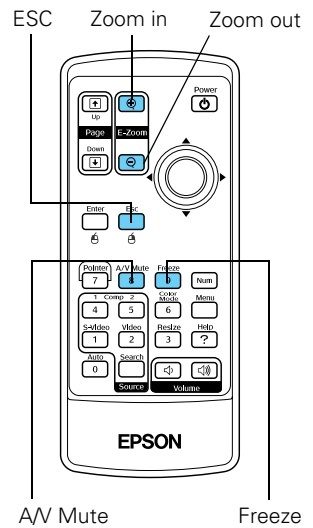
1. Press the **E-Zoom**  button on the remote control.
You see a crosshair indicating the center of the zoom-in area.
2. Use the  pointer button to position the crosshair in the area you want to enlarge.
3. Continue pressing the **E-Zoom**  button to enlarge the selected area up to 4 times.



4. While the image is enlarged, you can:
 - Use the  pointer button to pan about.
 - Press the E-Zoom  button to zoom out.
5. When you're done, press the ESC button to return to the original size.

note

You must be projecting component, composite, or S-Video images to change the aspect ratio.

You can also change the aspect ratio using the projector's Signal menu. See page 58 for details.

Changing the Image's Aspect Ratio



If you're projecting a widescreen format image, you can use the **Resize** button on the remote control to change the aspect ratio. Follow these steps:

1. Press the **Resize** button once to change the aspect ratio to 16:9 for widescreen format.
2. Press it again to return to 4:3 aspect ratio.

Using the Remote Control as a Wireless Mouse

When you use the remote control as a wireless mouse, you can control your computer or click through slide show-style presentations (such as PowerPoint) from up to 20 feet away. This gives you more flexibility, since you don't need to stand near your computer to change slides.

To control your computer with the remote, make sure you have connected your computer to the projector with a USB cable as described on page 21.

- To display the mouse pointer, press the **Pointer** button.
- To move the pointer on the screen, aim the remote at the screen and use the  pointer button.
- To click (or left-click), press the **Enter** button.
- To right-click, press the **Esc** button.
- To double-click, press the **Enter** button twice.
- To click and drag, press down and hold the **Enter** button and use the  pointer button to move where you want to drag.
- To advance slides in a PowerPoint presentation in Slide Show mode, press the **Page up** or **Enter** button on the remote control. Press the **Page down** or **Esc** button to go back a slide.

Left-click or double-click Move the pointer

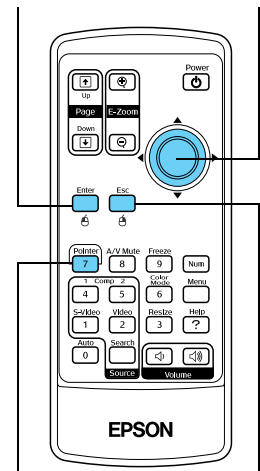

Display the pointer Right-click

Page down Page up

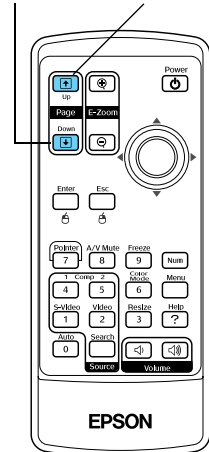

Replacing the Batteries

note

The remote control automatically shuts off when it detects a button being pressed more than 30 seconds. This conserves battery life. It can be helpful, for example, when the remote is in a carrying case and the **Power** button is accidentally pushed.

The remote control uses two AAA alkaline batteries. Follow these steps when you need to replace them:

1. Press in the tab to remove the battery cover.

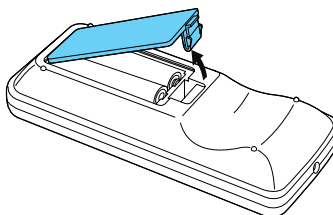

2. Remove the old batteries, then insert the new ones as shown.

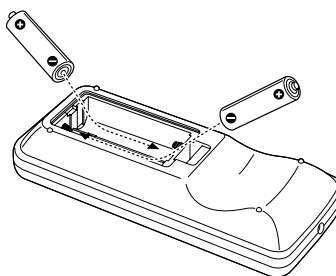

3. Replace the battery cover. (It should click into place.)

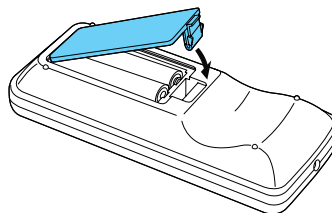

caution

When replacing batteries, take the following precautions:

- Replace the batteries as soon as they run out. If a battery leaks, wipe away battery fluid with a soft cloth. If fluid gets on your hands, wash them immediately.
- Do not expose batteries to heat or flame.
- Dispose of used batteries according to local regulations.
- Remove the batteries if you won't be using the remote control for a long period of time.

4

Fine-tuning the Projector

You can use the Menu button on the projector or remote control to access on-screen menus to adjust the image, sound, and other features. This chapter covers the following information:

- Using the menu system
- Adjusting image colors and clarity
- Adjusting the input signal
- Customizing projector features
- Selecting projector setup options
- Viewing lamp usage and other information
- Using the projector's security features
- Restoring the default settings



Using the Projector's Menu System

The six projector menus let you adjust and customize the projector features:

- The **Image** menu lets you modify the colors of the projected image and fine-tune brightness, contrast, and sharpness.
- The **Signal** menu lets you make adjustments to the input signal. You can select your input source, change the image position and aspect ratio, and adjust tracking and sync for computer images.
- The **Settings** menu lets you customize the way you use the projector. It allows you to adjust the volume and keystone correction, set lamp brightness to high or low, select the shape of the mouse pointer, and disable buttons on the projector while you are projecting.
- The **Extended** menu lets you customize the way you set up the projector. Among the options, you can select the menu language, set rear or ceiling projection, and record a custom image or logo to be displayed as the startup screen or whenever you press the **A/V Mute** button on the remote control.
- The **Info** menu provides information about lamp status and computer or video settings.
- The **Reset** menu lets you restore the projector's factory default settings.

4. After highlighting the option you want to adjust, use the  pointer button on the remote control or left or right arrow buttons on the projector to change the setting. In some cases, you may have to press the **Enter** button to see a sub-screen for changing the setting.



- Press the left or right side of the  pointer button or the left or right arrow buttons on the projector to adjust a slider bar.
 - To select from two or more settings, use the  pointer button or arrow buttons to highlight the desired setting, then press **Enter**.
5. Press the **Esc** button to return to the previous menu or to close the menu system if you are at the main menu. Your changes are saved automatically.
 6. Press the **Menu** button to exit the menu system.

Adjusting Colors and Clarity

The Image menu lets you make adjustments to the colors of the projected image and fine-tune brightness, contrast, and sharpness. The options available depend on which image source is selected:

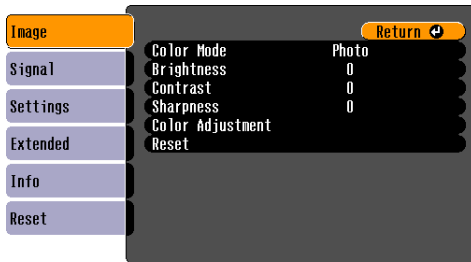

[Esc]/[Enter]:Return [↔]:Select [Menu]:Exit

Computer (analog-RGB) and RGB video

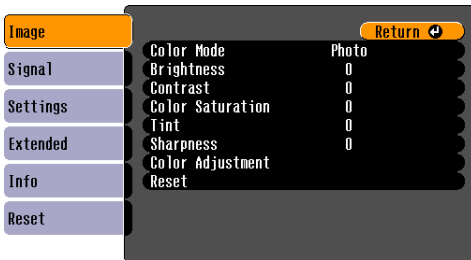

[Esc]/[Enter]:Return [↔]:Select [Menu]:Exit

Component, composite, and S-video

Follow these steps to adjust the appearance of your image:

1. Press the **Menu** button. You see the main menu.
2. Press **Enter** to select the Image menu.

3. Use the  pointer button (or the up and down arrow buttons) and press **Enter** to select any of the following options:

- **Color Mode**

Corrects the vividness of image color. You can select from the following settings, and save a different one for each computer and/or video source:

Photo: For projecting still images with vivid color in a bright room (Computer input only).

Sports: For watching TV in a bright room (component, S-Video, or composite video input only).

Presentation: For presentations in a bright room.

Theatre: For optimizing movie images with natural color in a dark room (the default for video or S-Video display).

Game: For playing video games in a bright room.

sRGB: For standard sRGB computer displays (the default when projecting from a computer with analog video).

Blackboard: Fixed color mode for projecting against a green blackboard.

- **Brightness**

Lightens or darkens the overall image.

- **Contrast**

Adjusts the difference between light and dark areas.

- **Color Saturation** (component, composite, and S-Video)

Adjusts the depth or intensity of the image colors.

- **Tint** (component, composite, and S-Video)

Adjusts the balance of green to magenta in the image.

note

You can also select High or Low brightness mode in the Settings menu. See page 61.

- **Sharpness**
Sharpens or softens the image.
 - **Color Adjustment**
Adjusts the temperature and intensity of red, green, and blue.
4. When the image is set correctly, press **Esc** or **Menu**. Your settings are automatically saved.

Adjusting the Input Signal

Although the projector normally detects and optimizes the input signal automatically, you can use the Signal menu to make manual adjustments. In addition to changing the position of the projected image, you can correct tracking and sync for computer images, or change the aspect ratio to widescreen format for video images.

1. Press the Menu button. You see the Image menu.
2. Select the Signal menu. You see one of the following screens:

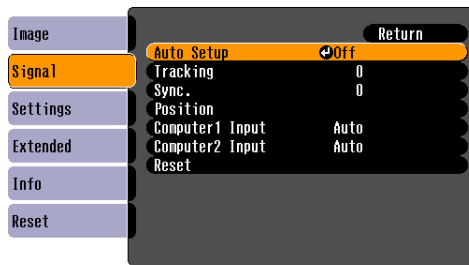

[Esc]:Return [◀]:Select [Enter]:Enter [Menu]:Exit

Computer (analog-RGB) and RGB video

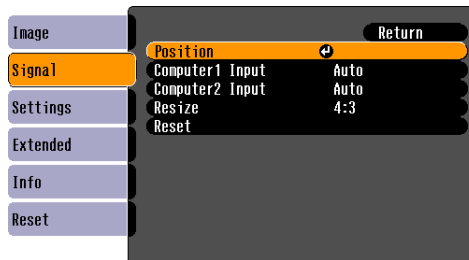

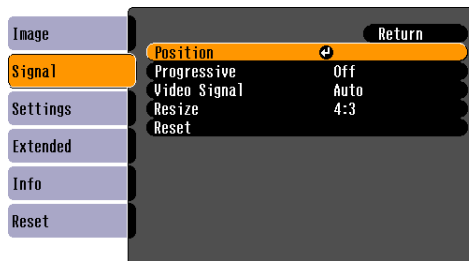

[Esc]:Return [◀]:Select [Enter]:Enter [Menu]:Exit

Component video



[Esc]:Return [◀]:Select [Enter]:Enter [Menu]:Exit

Composite video and S-video

3. Press **Enter**. Then use the  pointer button (or up and down arrow buttons) and the **Enter** button to select any of the following options:
 - **Auto Setup** (computer images)
Leave this setting **ON** to automatically optimize the computer image. Turn it off if you want to save adjustments you have made to the video settings.
 - **Tracking** (computer images)
Removes unwanted vertical lines from a computer image by matching the projector's internal clock to various computer signals. See page 91 for more information about adjusting the tracking.
 - **Sync** (computer images)
Corrects fuzziness or screen flicker by synchronizing the projector with the tracking signal sent from the computer. See page 91 for more information about adjusting the sync setting.
 - **Position**
Use the  pointer button or arrow buttons to move the image on the screen left, right, up, or down.
 - **Progressive**
Leave this setting **ON** when viewing S-Video or composite video so that interlaced-to-progressive conversion is carried out (best for fast-moving pictures). If you notice flickering while viewing still images, switch this setting to **OFF**.
 - **Computer 1 Input**
Selects the signal from equipment connected to the **Computer1(Component)** port. If your image colors look wrong, try changing this setting from **Auto** to one of the following: **RGB** for computer or RGB video sources, or **Component Video** for component video sources.

note

*If you have repositioned the image but then change your mind, you can press the **Auto** button on the remote control to restore the default settings.*

- **Computer 2 Input**
Selects the signal from equipment connected to the **Computer2(Component)** port. If your image colors look wrong, try changing this setting from **Auto** to one of the following: **RGB** for computer or **RGB** video sources, or **Component Video** for component video sources.
 - **Video Signal** (composite and S-Video)
Leave this setting at **Auto** unless you are using a 60-Hz PAL system (select **PAL60**).
 - **Resize** (video)
Sets the image's aspect ratio (ratio of width to height) to **4:3** for letterbox video content and to **16:9** for widescreen video content.
4. When you're finished adjusting the signal settings, press **Esc** or **Menu**.

Customizing Projector Features

The Settings menu lets you customize the way you use the projector, from adjusting lamp brightness and speaker volume to changing the shape of the mouse pointer.

1. Press the **Menu** button.
2. Select the **Settings** menu.

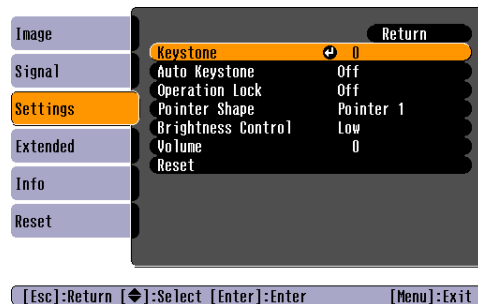

3. Press **Enter**. Then use the  pointer button (or up and down arrow buttons) and the **Enter** button to set the following options:



■ **Keystone**

Adjusts a distorted image from a trapezoid shape to rectangular.

■ **Auto Keystone**

Automatically adjusts a distorted image from a trapezoid shape to rectangular when the projector's foot is extended or retracted. (Not available when you're projecting from the ceiling or using rear projection.) Select **ON** or **OFF**.

■ **Operation Lock**

When turned on, this function disables all projector buttons except the  **Power** button. Changes to this setting take effect after you restart the projector. (After you turn off the projector, wait for the  power light to turn a steady orange before turning it on again.)

■ **Pointer Shape**

Lets you select from three different pointer shapes. The Password Protect function must be cancelled first. See page 68.

■ **Brightness Control**

Select **Low** lamp brightness when the projection is too bright for the room. The **Low** setting also reduces electricity consumption and fan noise. Select **High** to project the maximum brightness. (Also check the **Brightness** setting in the Image menu; see page 56.)

■ **Volume**

Adjusts the volume for the projector's speaker.

4. When you're finished, press **Esc** or **Menu**.

note

*To cancel the Operation Lock function from the projector, press the **Enter** button for about seven seconds.*

Selecting Projector Setup Options

Use the Extended menu to customize the way you set up the projector. You can configure the projector for rear and/or ceiling projection, change the language for the menus and messages, set the screen background color, capture and store a custom image or logo for the startup screen, and set up the projector for network use.

1. Press the **Menu** button.
2. Select the **Extended** menu. You see the features and their settings on the right side:

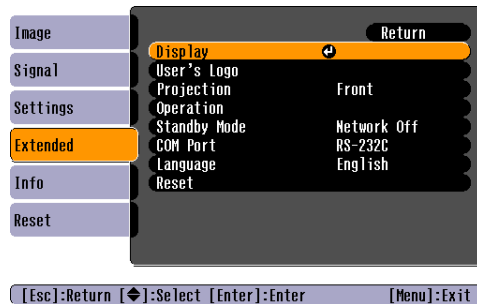

3. Press **Enter**. Then use the  pointer button (or the up and down arrow buttons) and the **Enter** button to set the following options:

- **Display**

Message: Lets you turn screen messages on or off.

Background Color: Sets the screen background to **Black**, **Blue**, or **Logo** when the **A/V Mute** button is pressed.

Startup Screen: Enables or disables display of the startup screen when the projector is turned on.

- **User's Logo**

Turn on to display the image or logo you have captured whenever the projector is turned on. See page 66 for more information.

note

The Startup Screen option cannot be turned off if the User's Logo Protect feature has been turned on. See page 68.

■ Projection

Front: Projector is in front of the screen.

Front/Ceiling: Projector is in front of the screen, mounted upside-down from the ceiling.

Rear: Projector is behind the screen.

Rear/Ceiling: Projector is behind the screen, mounted upside-down from the ceiling.

■ Operation

Direct Power: When this feature is enabled, projection starts as soon as you plug in the power cord. You don't have to press the  **Power** button.

Sleep Mode: When Sleep Mode is on, the projector turns off the lamp if it has not received any input signals for 30 minutes.

High Altitude Mode: When using the projector at an altitude above 4,921 feet, turn this setting on to ensure that the internal temperature of the projector is regulated properly. Turn this setting off for lower elevations.

- **Standby Mode:** Set to **Network ON** to monitor your projector over a network and perform other network functions when the projector is in standby mode.

■ COM Port



Turn on **USB** only if you're controlling the projector from a computer with the EMP Link 21L software. This software can be downloaded from the Epson website at support.epson.com. (You must turn the projector off and then on again to use the new setting.)

■ Language

Select the language to be used for the projector menus.

4. When you're finished, press **Esc** or **Menu**.

note

*When Direct Power is turned on, press the  **Power** button to turn the projector off, wait until the  power light turns a steady orange, then unplug the power cord.*

Viewing Lamp Usage and Other Information

note

You can make changes to many of the signal settings on the Signal menu. See page 58 for details.

Use the Info menu to view information about the display settings of your computer and the number of hours the lamp has been used.

1. Press the Menu button and select the Info menu. You see one of the following menus:



[◀]:Select [Menu]:Exit

Computer (analog RGB, digital RGB, RGB Video/Component video, YCbCr, YPbPr)

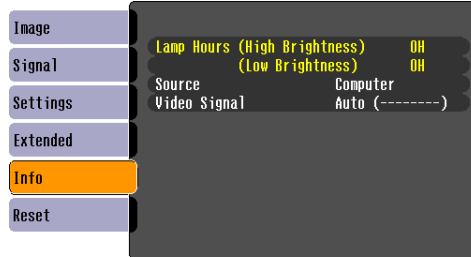

[◀]:Select [Menu]:Exit

Video (Composite video, S-Video)

note

The lamp usage timer doesn't register until you've used the lamp for at least 10 hours.

■ Lamp Hours

Displays the number of hours the lamp has been used. The life span of the lamp ranges from about 2000 hours in High brightness mode to about 3000 hours in Low brightness mode. If the number shown is close to 2000 or the information is displayed in red, make sure you have a spare lamp handy.

- **Source**
Displays the input source currently being projected.
 - **Input Signal** (computer, RGB video, and component video)
Displays the input signal setting.
 - **Resolution** (computer, RGB video, and component video)
Displays the input resolution.
 - **Video Signal** (composite and S-Video)
Displays the video signal format.
 - **Refresh Rate** (computer, RGB video, and component video)
Displays the refresh rate.
 - **Sync Info** (computer, RGB video, and component video)
Provides information that may be needed by the service technician.
2. When you're finished, press **Esc** or **Menu**.

Using the Projector's Security Features

To prevent unauthorized use of the projector, you can do the following:

- Create an identifying user logo that is displayed at startup and/or when the **AV Mute** button is pressed
- Assign a password; this can be disabled for a set period if you want to loan the projector to someone
- Disable the projector's buttons; this is useful, for example, if you're projecting in a classroom and you want to ensure that no one touches the projector's buttons while you're using the remote control

If you create a user's logo for the projector, you can lock the logo on so it is displayed as the startup screen and/or AV/Mute screen. Unauthorized users cannot turn it off or change it. This feature is intended to discourage theft and provides a way to identify the projector should it be stolen.

If you assign the projector a password, a screen appears requesting the password whenever the projector is turned on. If you enter the password incorrectly three times in succession, the projector's operation is locked and you'll need to disconnect the power cord, then reconnect it to redisplay the password screen. If an incorrect password is entered 30 times in a row, the projector is locked and you'll need to contact Epson to unlock it. See "Where To Get Help" on page 95.

note

If you should happen to enable the password before you set one and you see the prompt to enter the password, enter the default password 0000 to proceed.

If someone else will be using the projector for awhile but you want to make sure that person returns it by a certain time, you can temporarily disable the password for a set period. When that time has elapsed, the password is reactivated and must be entered before the projector can be used.

When you enable the Operation Lock feature, all of the projector's buttons are disabled except the  Power button.

Creating Your Own Screen Logo

You can transfer any image on your computer to the projector, and then use it as the startup screen and/or the screen that is displayed when you press the A/V Mute button. The image can be a company logo, slogan, photograph, or any other image you want to use. The projector considers this image the "User's Logo."



Follow these steps to capture the image and transfer it to the projector:

1. Display the image you want to use on the projector. You can use an image from either a computer or video source, such as a VCR.
2. Press the **Menu** button and select the **Extended** menu.

note

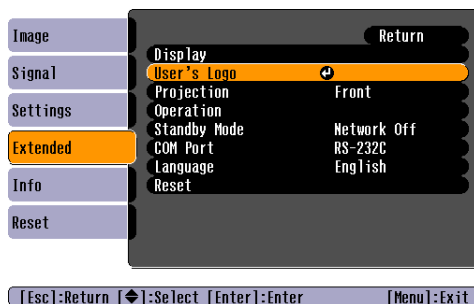
If the User's Logo Protect function is ON, you see a message that the logo cannot be recorded. You'll need to disable the User's Logo Protect function before you can create or change the User's Logo. See page 68.



3. Use the  pointer button (or the down arrow button) and press **Enter** to select **User's Logo**.
4. When you see a message asking if you want to use the present image as a user's logo, select **Yes** and press **Enter**. A selection box displays over the image.
5. Use the  pointer button on the remote control or the arrow buttons on the projector to select the area of the image you want to use. Once you have selected the area, press **Enter**.
6. When you see the message **Select this image?**, choose **Yes** and press **Enter**. If you want to change the area selected, select **No**, press **Enter** and repeat steps 5 and 6.
7. When you see this screen, select a zoom rate (display size), and then press **Enter**.

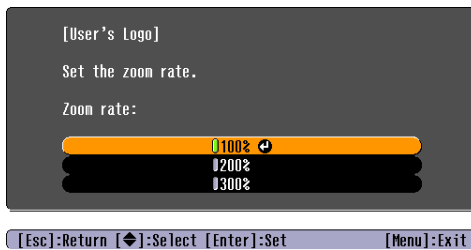

8. When you see the message **Save image as user's logo?**, select **Yes** and press **Enter**. Saving the logo takes a few moments. Do not use the projector or other sources (computer, video, etc.) while the logo is being saved.
9. When you see the message **Completed**, press **Esc**.
10. To display the logo as the background screen when the A/V Mute button is pressed, select the **Display** menu and press **Enter**.
11. Select **Background Color** and press **Enter**. Then select **Logo** and press **Enter**.
12. When you're finished, press **Menu** to exit the menus.

note

The default setting for the Startup Screen option in the Display menu is ON. If the Startup Screen is set to OFF, the logo will not display at startup.

If the User's Logo Protect function has been set to ON, the Background Color setting cannot be changed. You need to turn the protect function off first. See page 68 for details.

Once you've saved a user's logo, you cannot reset the logo setting to its factory default (no logo).

Setting a Password

1. Press the Freeze button on the remote control for about 7 seconds until you see the Password Protect menu:

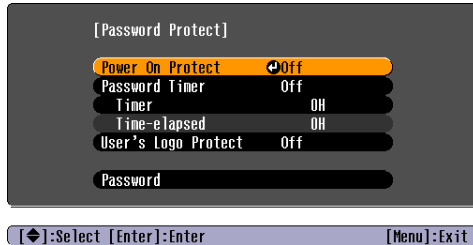

note

If a password has already been set, you see the Password Protect Release screen. See “Starting the Projector with a Password” on page 69.

Hold down this button to activate the numeric keypad

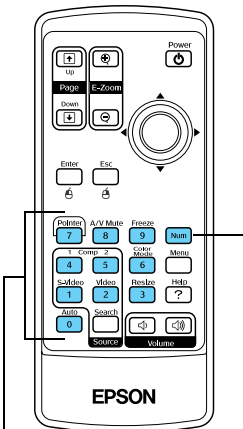

Use these buttons like a numeric keypad to enter the password

2. Select Password and press Enter. You see the message Change the password?
3. Select Yes and press Enter.
4. Hold down the Num key on the remote control and use the numeric keypad to enter a 4-digit password.

The password will be displayed as ****. After you enter the last digit, a confirmation screen appears. Enter the password again.

5. After you finish setting the password, press the Esc button to return to the Password Protect menu.

Make a note of the password and keep it in a safe place in case you forget it.

Turning On the Password and User's Logo

1. Press the Freeze button on the remote control for about 7 seconds until you see the Password Protect menu.
2. To enable the password, select Power ON Protect and press Enter. Select ON then press Esc.
3. If you want to disable the password temporarily, select Timer and press Enter. Then hold down the Num button while you use the numeric keypad to enter the number of hours (from 0 to 9999) that you want the password feature disabled. If you want the projector to request the password every time it is turned on, set the timer to 0H.

The countdown for the elapsed time begins as soon as you close the Password Protect menu. (You can check the elapsed time in this menu next to **Time elapsed**.)

4. To enable your screen logo, select **User's Logo Protect** and press **Enter**. Select **ON** and press **Enter**.

When this feature is on the logo appears whenever the projector is turned on (if the **Startup Screen** is enabled in the **Extended menu**; see page 62) and as the **A/V Mute** screen (if you selected the **Logo** as the **Background Color** in the **Extended menu**).

None of the **User's Logo** features can be changed when the **User's Logo Protect** function is enabled.

5. Press **Menu** to close the Password Protect menu.

If you lose the remote control, you will not be able to enter the password, so keep the remote control in a safe place at all times.

When the period defined in the **Time-elapsed** setting has passed, and the password is entered correctly, the elapsed time will be reset to **0** and the countdown will start again. Remember to disable or change this setting when you need to.

Starting the Projector with a Password

When the password function is enabled, you see this screen when you turn on the projector:

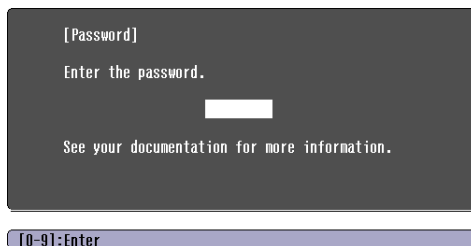

Press down the **Num** button on the remote control as you use the numeric keypad buttons to enter the password. Once you have entered the password correctly, the password screen closes, and projection begins.

If the password is not correct, you see the message **Wrong password. Please try again.** If you enter an incorrect password three times in succession, you see the message **The projector's operation will be locked. Request code xxxxx** and the projector switches to standby mode for approximately 5 minutes. Write down the request code. Then disconnect the projector's power cord from the electrical outlet, reconnect it, and turn the projector back on.

When you see the Password Protect Release screen again, you can try to enter the correct password.

If you have forgotten the password, contact Epson with the request code number that appears in the Password Protect Release screen for assistance. See "Where To Get Help" on page 95.

If you enter an incorrect password 30 times in succession, the projector remains locked and you must contact Epson to unlock it.

Disabling the Projector's Buttons

When you enable the Operation Lock function, all the projector's buttons are disabled except for the  Power button.

1. Press the **Menu** button.
2. Select the **Settings** menu and press **Enter**.
3. Use the  pointer button (or up and down arrow buttons) to select **Operation Lock** and press the **Enter** button.
4. Select **ON** and press **Enter**.
5. Select **Yes** and press **Enter** to confirm the setting.
6. Press the **Menu** button.

note

To cancel Operation Lock, press the projector's Enter button for seven seconds.

Restoring the Default Settings

The Reset menu lets you return most projector menu settings to their default values. It also lets you reset the lamp hours to their initial default value; see page 79 for instructions on resetting the lamp timer.

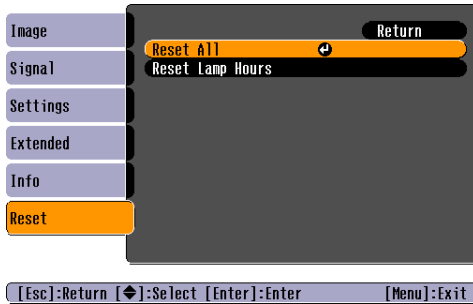

To reset most projector menu settings, select **Reset All** and press the **Enter** button to display the confirmation screen. Select **Yes** to reset all the default settings or **No** to cancel.

note

*The input signal, Video Signal, User's Logo, and Language settings do not return to their defaults when you select **Reset All**. To reset the input signal or video signal, use the **Reset** option on the Signal menu; see page 58 for details. To reset the User's Logo and Language settings, use the **Reset** option on the Extended menu; see page 62 for details.*

5 *Maintaining and Transporting the Projector*

warning

Before you clean any part of the projector, turn it off and unplug the power cord. Never open any cover on the projector, except the lamp and filter covers. Dangerous electrical voltages in the projector can injure you severely. Do not try to service this product yourself, except as specifically explained in this User's Guide. Refer all other servicing to qualified service personnel.

Your projector needs little maintenance. All you need to do on a regular basis is keep the lens clean. Any dirt or smears on the lens may show up on your projected image.

You also need to periodically clean the air filter and the air intake and exhaust vents. A clogged air filter or air vent can block ventilation needed to cool the projector and cause overheating.

The only parts you should replace are the lamp and air filter. If any other part needs replacing, contact your dealer or a qualified servicer.

This chapter covers the following:

- Cleaning the lens
- Cleaning the projector case
- Cleaning and replacing the air filter
- Replacing the lamp
- Resetting the lamp timer
- Transporting the projector

Cleaning the Lens

Clean the lens whenever you notice dirt or dust on the surface.

- Use a canister of compressed air to remove dust.
- To remove dirt or smears on the lens, use lens-cleaning paper. If necessary, moisten a soft cloth with lens cleaner and gently wipe the lens surface.

caution

Do not use glass cleaner to clean the lens.

Cleaning the Projector Case

Before you clean the case, first turn off the projector and unplug the power cord.

- To remove dirt or dust, wipe the case with a soft, dry, lint-free cloth.
- To remove stubborn dirt or stains, moisten a soft cloth with water and a mild detergent. Then wipe the case.
- Do not use wax, alcohol, benzene, paint thinner, or other chemical detergents. These can damage the case.

Cleaning and Replacing the Air Filter

Clean the air filter and air intake and exhaust vent on the bottom of the projector after every 100 hours of use. If they are not cleaned periodically, they can become clogged with dust, preventing proper ventilation. This can cause overheating and damage the projector. When the filter and vent are clogged, the projector displays the message **The projector is overheated**.

To clean the air filter and air vent, follow these steps:

1. Turn off the projector, allow it to cool down, and unplug the power cord.
2. Turn the projector upside-down and clean the filter and air intake vent on the base of the projector.

To clean the filter and air vent, Epson recommends using a small vacuum cleaner designed for computers and other office equipment. If you don't have one, gently clean them using a very soft brush (such as an artist's brush).

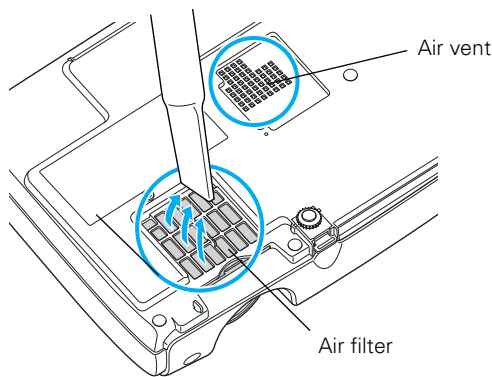

If the dirt is difficult to remove or if the filter is torn, replace it. Contact your dealer or call Epson at (800) 873-7766 to obtain a new one. The air filter set (part number V13H134A08) contains two filters. In Canada, please call (800) 463-7766 to locate a dealer.

3. If you need to replace the filter, slide it off, as shown.

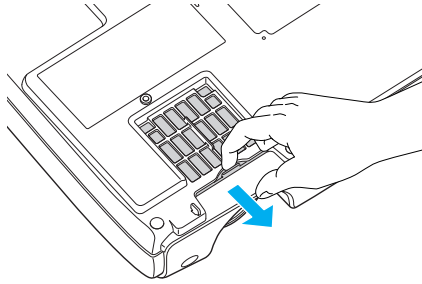

4. Align the new filter carefully as you slide it into place. It should click into place.

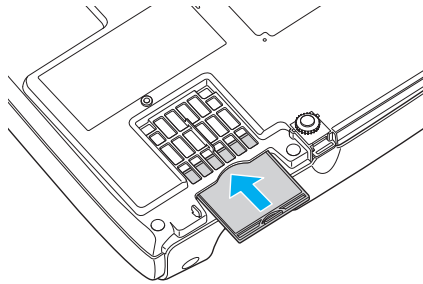

Replacing the Lamp

The projection lamp typically lasts for about 2000 hours of use (in high brightness mode) or 3000 hours (in low brightness mode). It is time to replace the lamp when:

- The projected image gets darker or starts to deteriorate.
- The  lamp light is flashing orange.
- The message **Replace the Lamp** appears on the screen when the lamp comes on. To maintain projector brightness and image quality, replace the lamp as soon as possible.

Contact your dealer or call Epson at (800) 873-7766 in the United States for a replacement lamp. Request part number V13H010L34. In Canada, please call (800) 463-7766 to locate a dealer.

Follow these steps to replace the lamp:

1. Press the  **Power** button twice to turn off the projector. When you hear the projector beep twice, unplug the power cord.
2. If the projector has been on, allow it to cool down for at least an hour (or until the lamp is cool).
3. Use the screwdriver included with the replacement lamp to loosen the screw holding the lamp cover (the lamp cover is located on top of the projector).
4. Slide the cover out, then lift it off.

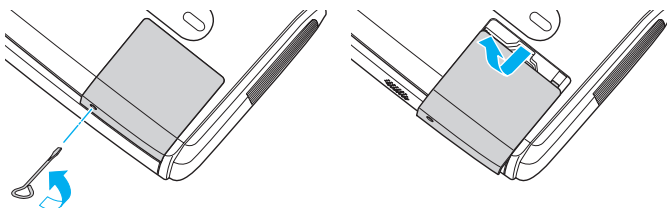

note

You can check to see how many hours the lamp has been used. See page 64.

Turn the projector off when not in use. Continuous 24-hour-a-day use may reduce the overall life of this product.

warning

Let the lamp cool before replacing it. If the lamp breaks, handle the shards carefully to avoid injury.

5. Use the screwdriver to loosen the two screws holding the lamp in place. (You can't remove the screws.)

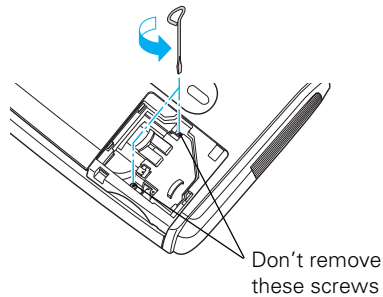

note

 The lamp(s) in this product contain mercury. Please consult your state and local regulations regarding disposal or recycling. Do not put in the trash.

6. Hold the lamp as shown and pull it straight out.

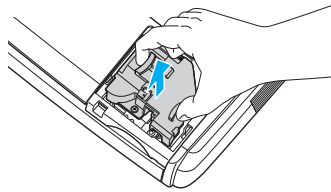

7. Gently insert the new lamp. If it doesn't fit easily, make sure it's facing the correct way.
8. Once the lamp is fully inserted, tighten its screws.

caution

Do not touch the glass portion of the lamp assembly. Touching the glass could result in premature lamp failure.

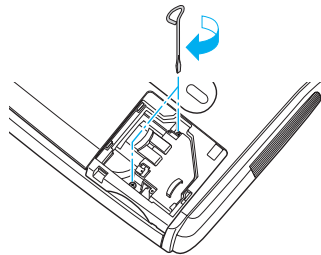

note

Be sure to seat the lamp fully and secure the lamp cover. If the lamp is not properly installed or the cover is loose, the lamp will not turn on.

- Lower the lamp cover into place. (The opening should be almost covered, and the top of the cover should be flush with the top of the projector.) Then slide the cover closed and tighten the screw.

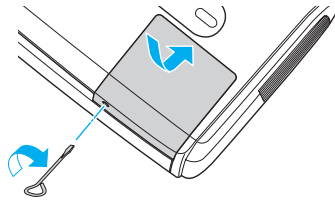

- Reset the lamp timer as described in the next section.

Resetting the Lamp Timer

You must reset the lamp timer after replacing the lamp to clear the Replace the Lamp warning message. Follow these steps:

- Connect the power cable and turn on the projector.
- Press the **Menu** button on the remote control or projector and select the **Reset** menu. Then press **Enter**. You see the following:

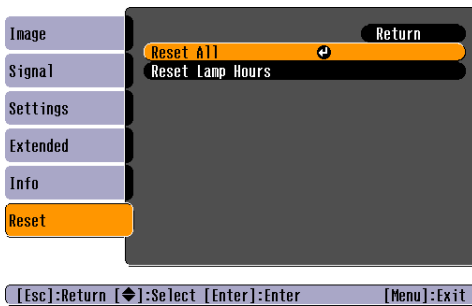

- Select the **Lamp-Hours Reset** option and press **Enter**. You see the following:

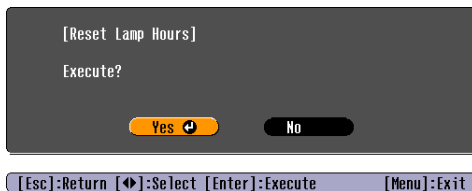

note

Do not reset the lamp timer if you have not replaced the lamp. If you do, the Lamp Hours will not accurately reflect the number of hours that the lamp has been used.

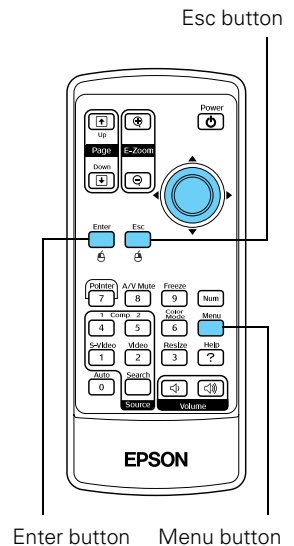

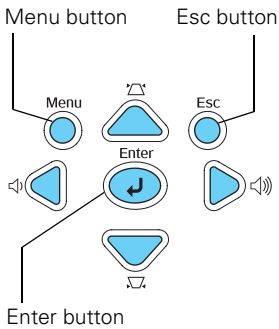

4. Select **Yes** and press **Enter**.
5. Press **Esc** to return to the main menu or the **Menu** button to exit the menu system.

Transporting the Projector

The projector contains many glass and precision parts. If you need to transport it, please follow these packing guidelines to prevent damage to the projector:

- When shipping the projector for repairs, use the original packaging material if possible. If you do not have the original packaging, use equivalent materials, placing plenty of cushioning around the projector.
- When transporting the projector as freight or checked luggage, first put it in the supplied carrying case, then pack it in a firm box, using cushioning around the case.
- When you are hand-carrying the projector, be sure to use the supplied carrying case.

note

Epson shall not be liable for any damages incurred during transportation.

6 *Solving Problems*

This chapter helps you solve problems with your projector, and tells you how to contact technical support for problems you can't solve yourself. This chapter explains the following:

- Using the projector's on-screen help system
- What to do when the projector's status lights flash
- Solving problems with the image or sound
- Solving password problems
- Solving problems with the remote control
- Contacting technical support

Using On-Screen Help

If the image doesn't look right or your audio isn't working, you can get help by pressing the ? Help button on the projector or remote control. The following choices are available:

- No signal or image appears on the screen
- Problems with sound
- Language change

Follow these steps to get help:

1. Press the ? Help button on the remote control or projector. You see the help menu.

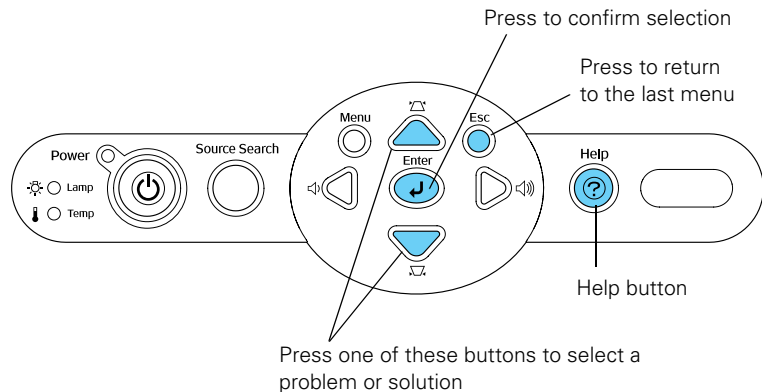
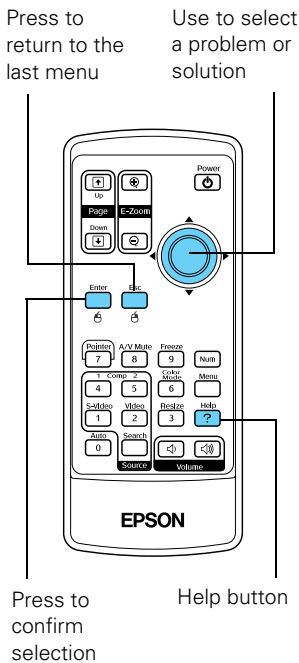

2. Use the pointer button on the remote control or the up and down arrow buttons on the projector to select an option. Then press the **Enter** button to select it.
3. Use the pointer button on the remote control or the up and down arrow buttons on the projector to highlight the problem you want to solve. Then press the **Enter** button to view the solution(s).

4. Highlight a solution (if this choice is available). Then press the **Enter** button to select the solution.

Press the **Esc** button if you need to back up.

If the solution is to adjust one of the settings, use the  pointer button on the remote control or the left and right arrow buttons on the projector to adjust it.

5. To exit the Help system, press the **? Help** button.

If none of the suggestions solves your problem, see additional solutions to problems in the following sections.

What To Do When the Lights Flash

The lights on top of the projector indicate the projector's status and let you know when a problem occurs.

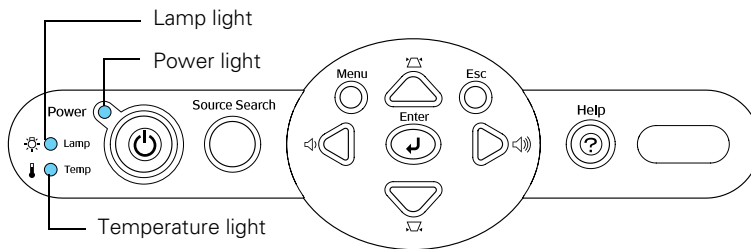

If the projector is not working correctly, first turn it off and unplug it. Then plug the power cord back in and turn on the projector. If this does not solve the problem, check the status lights on top of the projector and try the solutions recommended in the following table.

Power light	Lamp light	Temperature light	Description
Red	Flashing red	Flashing red	There is an internal error in the projector. Turn the projector off and unplug it. Contact Epson for help. See page 95.
Red	Off	Flashing red	There is a problem with the fan or a sensor. Turn the projector off and unplug it. Contact Epson for help. See page 95.
Red	Flashing red	Off	The lamp is burned out, broken, or not installed correctly; or the lamp cover is open. Close the cover or replace or reseal the lamp, if necessary, as described on page 77. If these suggestions don't work, contact Epson.
—	Flashing orange	Off	Replace the lamp with a new one as soon as possible; see page 77 for instructions. If you continue to use the lamp, there is a risk it may break.
Red	Off	Red	The projector has overheated and turned itself off. Let it cool for about five minutes, then turn it back on. Make sure there is plenty of space around and under the projector for ventilation. Also clean the air filter and air exhaust vents. See page 75. If it continues to overheat, you may need to replace the air filter.
Flashing red	Off	Flashing orange	The projector is too hot. Make sure the temperature surrounding the projector does not exceed 95 °F (35 °C) and there is plenty of space around and under the projector for ventilation. Clean the air filter and air vents, if necessary. See page 75 for instructions.
Orange	Off	Off	The projector is in standby or sleep mode. You can unplug it or press the  Power button to turn it on.
Flashing green	Off	Off	The projector is warming up. Wait for the image to appear.
Green	Off	Off	The projector is operating normally.
Flashing orange	Off	Off	The projector is shutting down. Wait for the light to stop flashing and remain orange before unplugging it.

Solving Problems with the Image or Sound

No image appears on the screen.

- Check that the power light is green, not flashing, and the lens cap is off.
- The projector may be in standby or sleep mode. If the projector has not received any input signal for 30 minutes, it turns off the lamp to conserve the lamp life and save energy. If the power light is orange, press the **⏻ Power** button to turn the projector on.
- Press the **A/V Mute** button to make sure the picture has not been turned off temporarily.
- If the power was switched off and then on again, wait until the power light stops flashing and remains orange; then press the **⏻ Power** button again.
- Check the **Video Signal** or **Computer1 Input** or **Computer2 Input** setting in the **Signal** menu to make sure it is correct for the selected source. See page 58 for more information.
- Have messages been turned off in the **Display** setting of the **Extended** menu? See page 62 for details.
- Adjust the **Brightness** setting on the **Image** menu or select **High** for the **Brightness Control** setting in the **Extended** menu. See page 56 or page 61.
- The attached computer may be in sleep mode or displaying a black screen saver. Try pressing a key on the computer.

Nothing appears on the external monitor.

- Make sure the VGA computer cable is connected to your computer's video port and the projector's Computer1(Component) port. It will not work if you connected the computer cable to the projector's Computer2(Component) port.
- Make sure the cable from your monitor is connected to the projector's Monitor Out port.

You see a blue screen with the message No Signal displayed.

- Make sure the cables are connected correctly, as described in Chapter 1.
- Make sure the power to your computer or video source is turned on.
- If you've connected a computer and one or more video sources, you may need to press the Source Search button on the projector or the Comp1, Comp2, S-Video, or Video button on the remote control to select the correct source. Allow a few seconds for the projector to sync up after pressing the button.
- If you've connected a laptop computer, make sure it's set to display on an external monitor. See page 35.

If you're using a PC laptop:

- Hold down the Fn key and press the function key that lets you display on an external monitor. It may have an icon such as , or it may be labelled CRT/LCD. Allow a few seconds for the projector to sync up after pressing it. Check your laptop's manual or online help for details.

On most systems, the  or CRT/LCD key lets you toggle between the LCD screen and the projector, or display on both at the same time.

- Depending on your computer's video card, you might need to use the Display utility in the Control Panel to make sure that both the LCD screen and external monitor port are enabled. See your computer's documentation or online help for details.

If you're using a PowerBook or iBook with Macintosh OS X:

1. From the Apple menu, select **System Preferences**, then click **Display** or **Displays**.
2. Select **VGA Display** or **Color LCD**, click **Arrange** or **Arrangement**, then put a check mark in **Mirror Displays**.

If you're using a PowerBook or iBook with Macintosh OS 9:

1. From the Apple menu, select **Control Panels**, then click **Monitors** or **Monitors and Sound**.
2. Click the **Arrange** icon.
3. Drag one monitor icon on top of the other. This lets you display on the projector screen as well as the LCD screen.
4. If the **Arrange** icon isn't available, click the **Monitor** icon.
5. Select one of the listed **Simulscan** resolutions. (Allow a few seconds for the projector to sync up after making the selection.)



The message Not Supported is displayed.

- Make sure your computer's resolution doesn't exceed XGA (for the PowerLite 82c) or SVGA (for the PowerLite 62c) and the frequency is supported by the projector. See page 100. If necessary, change your computer's resolution setting as described below.
- Make sure the correct **Video Signal** is selected in the **Signal** menu. See page 60. It should normally be set to **Auto**.

Only part of the computer image is displayed.

- If you're projecting from a computer or RGB video device, press the **Auto** button on the remote control. If this doesn't work or if you're projecting from a component, composite, or S-Video device, you may need to adjust the **Position** setting in the **Signal** menu. See page 59 for more information.
- If you've enlarged part of the image using the **E-Zoom** ⊕ button on the remote control, press the **Esc** button to cancel zooming and return to full display.
- Try pressing the **Resize** button on the remote control to select a different aspect ratio (ratio of length to height).
- Make sure your computer's resolution setting is correct. Ideally, it should be 1024 × 768 (for the PowerLite 82c) or 800 × 600 (for the PowerLite 62c) to match the projector's native resolution. If this option isn't available, select one of the other compatible video formats listed on page 100.
 - **Windows:**
Right-click the desktop, select **Properties**, click the **Settings** tab, and select a different resolution.
 - **Macintosh OS X:**
On the Apple menu, choose **System Preferences**, then click **Display** or **Displays**. Select a different resolution.
 - **Macintosh OS 9.x:**
On the Apple menu, choose **Control Panels**, then click **Monitors** or **Monitors and Sound**. Select a different resolution.
- You also may need to modify existing presentation files if you created them for a different resolution. See your software documentation for specific information.

The image isn't rectangular, but trapezoid-shaped.

- Make sure the projector isn't placed off to one side of the screen, at an angle, or the image won't be rectangular. Place it directly in front of the center of the screen, facing the screen squarely.
- If you've tilted the projector upward, the image will be broader at the top. Turn on Auto Keystone correction as described on page 60 or hold down the  or  buttons on top of the projector until the image is rectangular.

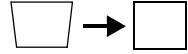
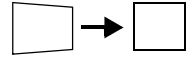

The image contains static or noise.

- If you're using a computer cable longer than 6 feet, or an extension cable, the image quality may be reduced.
- Keep your computer and video cables separated from the power cord as much as possible to prevent interference.

- The video signal may be split between the computer and the projector. If you notice a decline in the projected image quality when the image is displayed simultaneously on your laptop computer and the projector, turn off the laptop's LCD display.
- If you're projecting from a composite or S-Video source, check the **Video Signal** setting in the Signal menu. In most cases, leave it set at **Auto**. If you're using a 60-Hz PAL video source, change this setting to **PAL60**. See page 60 for details.
- Make sure the cables are securely connected at both ends.
- Select the correct resolution; see "Compatible Video Formats" on page 100.
- If you're projecting from a computer, press the **Auto** button on the remote control or the **Enter** button on the projector to adjust tracking and sync automatically. If that doesn't work, try adjusting the **Sync** and **Tracking** settings in the Signal menu. See page 59.

The image is blurry.

- Adjust the focus using the focus ring.
- Make sure the lens cap is off.
- There may be dirt or smears on the lens. Clean the lens as described on page 74.
- Make sure the lens is not fogged by condensation. You may need to wait before using the projector after moving it from a cold environment.
- Make sure the projection distance is within the range described on page 16.
- Adjust the **Sharpness** setting on the Image menu (see page 57). You should be able to see the effect on the screen immediately.

You see vertical stripes or the image still looks blurry after trying the solutions in the previous section.

- If you're projecting from a computer and displaying an image that contains a lot of fine detail, you may notice one or more vertical stripes or bands, or some of the characters may look heavy or blurred. Press the **Auto** button on the remote control. This resets the projector's tracking and sync settings.
- If further adjustment is needed, you can fine-tune the **Tracking** and **Sync** settings manually using the **Signal** menu as described on page 59.
 1. Fill the screen with an image containing fine detail when making these adjustments. For example, in Windows you can select a pattern to appear as your desktop background. Or try projecting black text on a white background.
 2. Adjust the **Tracking** to eliminate vertical stripes.
 3. Adjust the **Sync** to increase the sharpness of the image.

The colors of the image are not right.

- Try selecting a different **Color Mode**. See page 56 for instructions.
- If you're displaying video, adjust the **Color Saturation** and **Tint** settings on the **Image** menu. See page 56 for instructions.
- Adjust the **Brightness** and **Contrast** settings on the **Image** menu. See page 56.
- Try adjusting the **Color Adjustment** setting on the **Image** menu. See page 57.
- Make sure the input signal setting on the **Signal** menu matches the signal from the connected device. If the image is too purple and you've connected a computer or RGB video device to the **Computer1(Component)** or **Computer2(Component)** port, select **Computer1** or **Computer2** as the input source. If you've connected a component video device to one of these ports, select **Component Video1** or **Component Video2**. If you're



note

Because of the different technologies used, your projected image may not exactly match the colors on your laptop or computer monitor.

projecting from a composite video or S-Video source, make sure the correct **Video Signal** is selected on the Signal message. See page 58 for details.

- Check your computer display settings to correct the color balance.
- If the image seems dark, the lamp may be nearing time for replacement. Check the lamp hours as described on page 64 and replace it, if necessary, as described on page 77.

There is no sound.

- Press the  button on the remote control or projector to turn up the volume.
- If you've turned off the picture and sound, press the **A/V Mute** button on the remote control to turn them on again.
- If you're using a VCR or other video source, make sure its volume is not turned all the way down or muted. Also, make sure the cables are connected correctly, as described in Chapter 1.
- Make sure the audio cable is connected to the correct Audio port. See page 23.
- If your presentation includes computer audio, make sure the volume control on your computer is not turned all the way down or muted. Make sure the audio cable is securely connected to both the projector and your computer's  headphone jack or  audio out jack. See page 23.
- The wrong source may be selected. Press the **Source Search** button on the projector—or the **Comp1**, **Comp2**, **S-Video**, or **Video** button on the remote control—to select the correct source.

Solving Password Problems

You have forgotten the password.

- Write down the request code that appears in the Password Protect Release screen and contact Epson. See “Where To Get Help” on page 95.
- If you turned on the password protect feature before setting the password and no password was set before, try using the default password: 0000.

The remote control is not available.

You must have the remote control to enter the password. If necessary, you can purchase a replacement remote control from Epson. See page 96 for details about ordering.

Solving Problems with the Remote Control

The projector doesn't respond to remote control commands.

- Make sure you are within 20 feet of the projector, and within range of the projector's front or back sensor (approximately 30° to the left or right and 15° above or below).
- The remote control batteries may not be installed correctly or may be low on power. Replace the batteries as described on page 50.
- Dim the room lights and turn off any fluorescent lights. Make sure the projector is not in direct sunlight. Strong lighting, especially fluorescent lights, may affect the projector's infrared receivers.
- Turn off any nearby equipment that emits infrared energy, such as a radiant room heater.

You have lost the remote control.

You need the remote control to access many projector features. If you have lost it, you can order another from Epson. See page 96 for details about ordering.

You can't control the mouse pointer with the remote control.

- Make sure the USB mouse cable is securely connected to both your computer's USB port and the projector's USB port. For details, see page 21.
- Your computer must be connected to the **Computer1(Component)** or **Computer2(Component)** port on the projector in order to control your mouse pointer with the remote control.
- Make sure **USB** is selected as the COM Port setting in the Extended menu. See page 63.
- To use the USB mouse connection on a PC, your system must have a "clean" installation of Windows 98, Windows Me, Windows XP, or Windows 2000. The connection may not work correctly if your system was upgraded from Windows 95.
- If you're running Windows 98 or Me, you may need to install USB drivers from your Windows CD-ROM. After you install the drivers, restart both the computer and the projector to resynchronize the setup.

Where To Get Help

Epson provides technical assistance through electronic support services 24 hours a day, as listed in the following table.

Service	Access
World Wide Web	From the Internet, you can reach Epson's product support page at http://support.epson.com . After selecting your product, you can access troubleshooting information, download product documentation, and receive technical advice through e-mail.
Presenters Online	Access tips, templates, and training for developing successful presentations at http://www.presentersonline.com

Telephone Support Services

To use the Epson PrivateLine Support service, call (800) 637-7661 and enter the PIN on the Epson PrivateLine Support card included in your Start Here kit. This is the fastest way of speaking to a live representative, and it's free. This service is available 6 AM to 6 PM, Pacific Time, Monday through Friday, for the duration of your warranty period.

You may also speak with a projector support specialist by dialing one of these numbers:

- U.S.: (562) 276-4394, 6 AM to 6 PM, Pacific Time, Monday through Friday
- Canada: (905) 709-3839, 6 AM to 6 PM, Pacific Time, Monday through Friday

Toll or long distance charges may apply.

Before you call, please have the following information ready:

- Product name (Epson PowerLite 62c or PowerLite 82c)
- Product serial number (located on the bottom of the projector)
- Computer or video configuration
- Description of the problem

note

To purchase a replacement remote control, call (562) 276-4394 (U.S.) or (905) 709-3839 (for dealer referral in Canada).

You can purchase video cables, screens, carrying cases, or other accessories from an Epson authorized reseller. Please call 800-GO-EPSON (800-463-7766) for product information and to find the nearest authorized reseller. To purchase online, visit the Epson Store at www.epsonstore.com (U.S. sales only). In Canada, please call (800) 463-7766 for dealer referral.

A *Technical Specifications*

General

Type of display	Poly-silicon TFT active matrix with MLA
Lens	F=1.6, 18.4 to 22.12 mm
Resolution	82c: 1024 × 768 pixels (XGA) 62c: 800 × 600 pixels (SVGA)
Color reproduction	Full color, 16.77 million colors
Brightness (ANSI)	2000 lumens (High brightness mode) 1500 lumens (Low brightness mode)
Contrast ratio	400:1
Image size	30 to 300 inches (0.8 to 7.6 meters)
Projection distance	2.8 to 35.4 feet (0.9 to 10.8 meters)
Projection methods	Front, rear, ceiling
Focus adjustment	Manual
Zoom adjustment	Manual
Internal sound system	5 W monaural
Optical aspect ratio	4:3 (horizontal:vertical)
Zoom ratio	1:1.2
Noise level	36 dB (High brightness mode) 30 dB (Low brightness mode)
Keystone correction angle	± 30° vertical (maximum)

note

Lamp life results vary depending on environmental conditions and usage.

Turn the projector off when not in use. Continuous 24-hour-a-day use may reduce the overall life of the product.

Projection Lamp

Power consumption	170 W UHE
Lamp life	About 2000 hours (High brightness); 3000 hours (Low brightness)

Remote Control

Range	20 feet (6 meters)
Batteries (2)	Alkaline AAA

Mouse Compatibility

Supports USB

Dimensions

Height	3.4 to 3.9 inches (foot extended) (86 to 98 mm)
Width	12.9 inches (327 mm)
Depth	9.7 inches (246 mm)
Weight	5.9 lb (2.7 kg)

Electrical

Rated frequency	50/60 Hz
Power supply	100 to 120 VAC, 2.9 A 200 to 240 VAC, 1.2 A
Power consumption	Operating: 250 W Standby: 4 W

Environmental

Temperature	Operating: 41 to 95 °F (5 to 35 °C) Storage: 14 to 140 °F (-10 to 60 °C)
Humidity	Operating: 20 to 80% RH, non-condensing Storage: 10 to 90% RH, non-condensing
Altitude	Up to 4,921 feet (1,500 m) Up to 7,500 feet (2,286 m) with high altitude mode enabled

Safety and Approvals

United States	FCC 47CFR Part15B Class B (DoC) UL60950 Third Edition
Canada	ICES-003 Class B CSA C22.2 No. 60950 (cUL)
CE Marking	Directive 73/23/EEC, 89/336/EEC IEC60950 Third Edition EN 55022, EN 55024



Pixelworks™ DNX™ ICs are used in this projector.

Compatible Video Formats

You can use any of the following video sources: VCR, DVD player, camcorder, digital camera, gaming console, or laser disc player. The projector supports composite video, S-Video, component video, and RGB video, and it automatically senses the video format (HDTV, SDTV, NTSC, PAL, or SECAM).

The projector supports these international video standards:

Mode	Refresh Rate (Hz)
NTSC	60
NTSC 4:3	60
PAL	50
M-PAL	60
N-PAL	50
PAL60	60
SECAM	50
TV525i	60
TV625i	50
SDTV480p	60
SDTV480p	50
HDTV720p	60
HDTV720p	50
HDTV1080i	60
HDTV1080i	50

Compatible Computer Display Formats

You can connect the projector to a wide range of computers, including PCs and notebooks, Apple Macintosh, Power Macintosh series (including G3, G4 and G5 systems), PowerBook computers, many iMac and iBook series systems, and high-end workstations such as the Sun[®] SPARCstation.[™]

Although images are displayed at the projector's native resolution of 1024 × 768 pixels (PowerLite 82c) or 800 × 600 pixels (PowerLite 62c), Epson's patented SizeWise chip supports computer display formats ranging from VGA through UXGA.

To project images output from a computer, the computer's external monitor signal must be set at a refresh rate (vertical frequency) that's compatible with the projector; see the following table for compatible formats. For best results, the computer's resolution should be set to match the projector's native resolution (1024 × 768, or 800 × 600). If this resolution isn't available, select one of the other compatible formats:

■ **Windows:**

Right-click the desktop, select **Properties**, click the **Settings** tab, and select a compatible resolution. (For a notebook displaying through an external monitor port, you'll need to click the **Advanced** button on the Settings tab, then adjust the resolution of the external monitor.)

■ **Macintosh OS X:**

From the Apple menu, select **System Preferences**, then click **Displays**. Make sure the **VGA Display** or **Color LCD** dialog box is selected, then click the **Display** tab and select a compatible resolution.

■ **Macintosh OS 9.x:**

On the Apple menu, choose **Control Panels**, then click **Monitors** or **Monitors and Sound**. Click the **Monitor** tab and select a compatible resolution for your external monitor.

You may need to modify existing presentation files if you created them for a different resolution. See your software documentation for details.

The projector supports these monitor display formats:

Mode	Refresh Rate (Hz)	Resolution
VGA EGA	70	640 × 350
VGA—60	60	640 × 480
VESA—72	72	640 × 480
VESA—75	75	640 × 480
VESA—85	85	640 × 480
SVGA—56	56	800 × 600
SVGA—60	60	800 × 600
SVGA—72	72	800 × 600
SVGA—75	75	800 × 600
SVGA—85	85	800 × 600
XGA—60	60	1024 × 768
XGA—70	70	1024 × 768
XGA—75	75	1024 × 768
XGA—85	85	1024 × 768
SXGA1—70	70	1152 × 864
SXGA1—75	75	1152 × 864
SXGA1—85	85	1152 × 864
SXGA2—60	60	1280 × 960
SXGA2—75	75	1280 × 960
SXGA2—85	85	1280 × 960
SXGA3—60	60	1280 × 1024
SXGA3—75	75	1280 × 1024
SXGA3—85	85	1280 × 1024
SXGA+60	60	1400 × 1050
SXGA+75	75	1400 × 1050
SXGA+85	85	1400 × 1050
UXGA—60	60	1600 × 1200
iMAC VGA	117	640 × 480
iMAC SVGA	95	800 × 600
iMAC XGA	75	1024 × 768
MAC13	67	640 × 480
MAC16	75	832 × 624
MAC19—60	59	1024 × 768
MAC19	75	1024 × 768
MAC21	75	1152 × 870

B

Notices

This chapter includes safety instructions and other important information about your Epson PowerLite projector.

Important Safety Instructions

Follow these safety instructions when setting up and using the projector:

- Do not place the projector on an unstable cart, stand, or table.
- Do not use the projector near water or sources of heat.
- Use the type of power source indicated on the projector. If you are not sure of the power available, consult your dealer or power company.
- Place the projector near a wall outlet where the plug can be easily unplugged.
- Insert the projector's two-wire plug into a properly grounded outlet. Do not hold the plug with wet hands.
- Take the following precautions for the plug. Failure to comply with these precautions could result in sparks or fire: Do not insert the plug into an outlet with dust present. Insert the plug firmly into the outlet.
- Do not overload wall outlets, extension cords, or integral convenience receptacles. This can cause fire or electric shock.
- Do not place the projector where the cord can be walked on. This may result in fraying or damage to the plug.
- Unplug the projector from the wall outlet before cleaning. Use a damp cloth for cleaning. Do not use liquid or aerosol cleaners.
- Do not block the slots and openings in the projector case. They provide ventilation and prevent the projector from overheating. Do not operate the projector on a sofa, rug, or other soft surface, or in a closed-in cabinet unless proper ventilation is provided.
- Never push objects of any kind through the cabinet slots. Never spill liquid of any kind into the projector.

- Except as specifically explained in this *User's Guide*, do not attempt to service this product yourself. Refer all servicing to qualified personnel. Opening or removing covers may expose you to dangerous voltages and other hazards.
- Unplug the projector from the wall outlet and refer servicing to qualified service personnel under the following conditions: When the power cord or plug is damaged or frayed. If liquid has been spilled into the projector, or if it has been exposed to rain or water. If it does not operate normally when you follow the operating instructions, or if it exhibits a distinct change in performance, indicating a need for service. If it has been dropped or the housing has been damaged.
- (Hg) The lamp(s) in this product contain mercury. Please consult your state and local regulations regarding disposal or recycling. Do not put in the trash.
- Unplug the projector during lightning storms or when it will not be used for extended periods.
- Do not place the projector and/or remote control on top of heat-producing equipment or in a hot location.
- If you use the projector in a country other than where you purchased it, use the correct power cord for that country.
- Do not stand on the projector or place heavy objects on it.
- Do not use the projector outside of the required temperature range of 41 to 95 °F (5 to 35 °C). Doing so may cause an unstable display and could lead to projector damage.
- Do not store the projector outside of the required temperature range of 14 to 140 °F (-10 to 60 °C) or in direct sunlight for long periods of time. Doing so may cause damage to the case.

WARNING: The cords included with this product contain chemicals, including lead, known to the State of California to cause birth defects or other reproductive harm. ***Wash hands after handling.*** (provided in accordance with Proposition 65 in Cal. Health & Safety Code § 25249.5 et seq).

Remote Control Information

You can operate the projector by remote control via a line-of-sight infrared (IR) receiver at the front and rear of the projector. The projector may not respond to remote control commands under the following conditions:

- There is an object between the remote control IR emitter and the IR receiver on the projector.
- Ambient light is too bright.
- Certain types of fluorescent lighting are used.
- A strong light source shines into the IR receiver.
- Other equipment that emits infrared energy, such as a radiant room heater, is in the room.

These conditions commonly cause problems for most infrared-controlled equipment. Try the following:

- The remote control's batteries may be low on power; replace them.
- Dim the ambient lighting and/or turn off any fluorescent lights.
- Close any window coverings and/or move the projector out of direct sunlight.
- Turn off other equipment that emits infrared energy.

FCC Compliance Statement

For United States Users

This equipment has been tested and found to comply with the limits for a Class B digital device, pursuant to Part 15 of the FCC Rules. These limits are designed to provide reasonable protection against harmful interference in a residential installation. This equipment generates, uses, and can radiate radio frequency energy and, if not installed and used in accordance with the instructions, may cause harmful interference to radio or television reception. However, there is no guarantee that interference will not occur in a particular installation. If this equipment does cause interference to radio and television reception, which can be determined by turning the equipment off and on, the user is encouraged to try to correct the interference by one or more of the following measures:

- Reorient or relocate the receiving antenna.
- Increase the separation between the equipment and receiver.
- Connect the equipment into an outlet on a circuit different from that to which the receiver is connected.
- Consult the dealer or an experienced radio/TV technician for help.

WARNING

The connection of a non-shielded equipment interface cable to this equipment will invalidate the FCC Certification or Declaration of this device and may cause interference levels which exceed the limits established by the FCC for this equipment. It is the responsibility of the user to obtain and use a shielded equipment interface cable with this device. If this equipment has more than one interface connector, do not leave cables connected to unused interfaces. Changes or modifications not expressly approved by the manufacturer could void the user's authority to operate the equipment.

For Canadian Users

This Class B digital apparatus meets all requirements of the Canadian Interference-Causing Equipment Regulations.

Cet appareil numérique de la classe B respecte toutes les exigences du Règlement sur le matériel brouilleur du Canada.

Index

A

- A/V cable, 24 to 25
- A/V Mute, 47, 62, 66 to 67, 85, 92
- Accessories, 13, 96
- Adapters, Macintosh, 19
- Air filter
 - cleaning and replacing, 75 to 76
 - purchasing, 13
- Anti-theft device, 13
- Aspect ratio, 48, 60, 97
- Audio
 - adjusting volume, 42, 61
 - cable, 23, 92
 - connecting laptop, 23
 - problems, troubleshooting, 92
 - turning off, 47
- Audio adapter, 29
- Auto button, 40, 59
- Auto Keystone correction, 17, 39, 52, 61
- Auto Setup setting, 40, 59

B

- Background Color setting, 62, 69
- Banding in image, 91
- Batteries, replacing, 50
- Blackboard color mode, 41, 56
- Blank screen, 34 to 37, 85 to 87
- Blue background, 62
- Blurry image, 90
- Brightness, 7, 40, 56, 77, 85, 91, 97
- Brightness Control setting, 40, 85
- Brightness setting, 91
- Buttons, disabling projector, 61

C

- Cables, 10 to 13, 96
- Camcorder, connecting to, 24
- Carrying case, 10 to 13, 80
- Ceiling
 - mount, 13, 17
 - projection, 17, 63
- Cleaning
 - air filter and vents, 75 to 76
 - lens, 74
 - projector case, 74
- Color
 - adjusting, 41, 55 to 57
 - problems, 91 to 92
 - specifications, 97
- Color Adjustment setting, 57
- Color Intensity setting, 56
- Color Mode, 41, 56
- COM Port setting, 63
- Comp1/Comp2 buttons, 34, 46, 86
- Component video cable, 12 to 13, 24, 28
- Component video source, selecting, 28, 34, 46, 59
- Composite video cable, 24 to 25
- Computer
 - cable, 10, 19 to 20
 - connecting to projector, 18 to 20
 - source, selecting, 20, 34, 46, 59 to 60
 - support, 7
 - supported display formats, 101 to 102
- Computer/Component Video ports, 19 to 20, 27, 46
- Connecting projector
 - to a computer, 18 to 23
 - to a video source, 24
- Contrast, 56, 91, 97

D

- Default password, 66
- Default settings, restoring, 71
- Digital camera, connecting to, 24
- Dimensions, 98
- Direct Power setting, 63
- Distance from projector to screen, 16, 97
- Documentation, using, 9
- DVD player, connecting to, 24

E

- Electrical specifications, 98
- Enter button, 49, 53 to 54
- Entering the password, 69 to 70
- Environmental specifications, 99
- Epson
 - accessories, 13, 96
 - Extra Care Road Service, 10
 - PrivateLine Support, 9, 95
 - Store, 13, 96
 - technical support, 9, 95 to 96
- Esc button, 49, 53 to 54
- Extended menu, 52, 62 to 63
- Extra Care Road Service, 10
- E-Zoom button, 47 to 48

F

- FCC compliance statement, 106
- Filter, cleaning and replacing, 75 to 76
- Focusing, 38
- Foot release levers, 38
- Freeze button, 47
- Front projection, 16 to 17, 63
- Front/Ceiling setting, 17, 63

G

- Game color mode, 56

H

- Height of image, adjusting, 38 to 39
- Help, 9, 95 to 96
- Help system, using, 82 to 83
- High altitude mode, 63
- High brightness, 40, 77, 85, 97

I

- iBook, connecting to, 18 to 20
- iMac, connecting to, 12, 18 to 20
- Image
 - capturing and saving in projector, 66 to 67
 - correcting shape of, 39, 61, 89
 - fitting on screen, 40, 59, 60, 88
 - focusing, 38
 - freezing, 47
 - height, adjusting, 38 to 39
 - menu, 52, 55 to 57
 - positioning, 38 to 39, 40, 59
 - problems, 85 to 92
 - raising, 38 to 39
 - selecting source, 20, 25, 33, 34, 46, 59 to 60
 - shape, correcting, 39, 61, 89
 - size and projection distance, 16, 97
 - turning off, 47
 - zooming, 38, 47 to 48
- Info menu, 52, 64 to 65
- Input signal, selecting, 20, 25 to 28, 34, 46, 59 to 60

K

- Kensington anti-theft device, 13
- Keystone correction, 39, 61, 89, 97

L

Lamp

- automatic shutoff, 42
- brightness, 7, 77, 85, 97
- number of hours used, 64, 77, 79, 98
- replacing, 77 to 80
- specifications, 98
- status light, 83 to 84
- timer, resetting, 79 to 80

Language setting, 63

Laptop computer

- connecting to, 18 to 20
- displaying on, 35 to 37, 86 to 87

Laser disc player, connecting to, 24

LCD panels, 7

Lens

- cleaning, 74
- specifications, 97

Lights, status, 83 to 84

Living Room color mode, 41

Logo

- creating, 66 to 67
- displaying, 67 to 69
- turning on, 62, 68 to 69

Low brightness, 40, 77, 97

M

Macintosh

- adapters, 19
- connecting, 18 to 20

Manuals, 9

Menus

- changing settings, 53 to 54
- Extended, 52, 62 to 63
- Image, 52, 55 to 57
- Info, 52, 64 to 65
- Reset, 52, 71
- Settings, 52, 60 to 61
- Signal, 52, 58 to 60
- User's Logo, 66 to 67
- using, 52 to 54

Message setting, 62

Mouse

- compatibility, 98
- connecting cable, 21
- using remote control as, 49

Moving projector, 80

N

Noise level, 97

O

Operation Lock setting, 61, 70

Options for projector, 13, 96

P

Page up and Page down buttons, 49

Password

- default, 66
- entering, 69 to 70
- logo protection, 66 to 70
- problems, 93
- prompt, 33, 69
- request code, 70
- setting, 68
- turning on, 68 to 69

Photo color mode, 41, 56

Picture source, selecting, 20, 25 to 28, 34, 59 to 60

Pixelworks, 99

Pointer

- changing shape, 61
- problems with, 94
- using, 49

Position setting, 59

Positioning

- image, 38 to 39, 59
- projector, 16 to 17

Power

- button, 33, 42
- consumption, 98
- light, 32, 83 to 84
- saving, 42
- supply, 98

PowerBook, connecting to, 18 to 20

Presentation color mode, 41, 56

Presenters Online, 9, 95

PrivateLine Support, 9, 95

Problems

color, 91 to 92

image, 85 to 92

password, 93

pointer, 94

remote control, 93 to 94, 105

sound, 92

Projection lamp, *see* Lamp

Projector

accessories, 13, 96

carrying case, 10 to 13, 80

cleaning, 73 to 76

disabling buttons, 61, 70

distance from screen, 16, 97

feet, adjusting height with, 38

lamp specifications, 98

parts, 11

password protection, 65 to 70

positioning, 16 to 17

resolution, 7, 97, 101 to 102

transporting, 80

turning off, 42 to 43

turning on, 32 to 33

unpacking, 10

viewing information about, 64 to 65

Q

Quick Setup sheet, 9

R

Raising image, 38 to 39

RCA A/V cable, 24 to 25

Rear projection, 17, 63

Registration, 10

Remote control

problems, 93 to 94, 105

replacing, 13, 96

replacing batteries, 50

specifications, 98

using, 45 to 49

wireless mouse, using as, 49

Replacing

air filter, 75 to 76

lamp, 77 to 80

remote control, 13, 96

remote control batteries, 50

Request code, password, 70

Reset menu, 52, 71

Resize button, 48

Resize setting, 60

Resolution, 7, 65, 97, 101 to 102

S

Safety

approvals, 99

instructions, 103 to 104

Screen logo, *see* User's Logo

Screen, distance from projector, 16, 97

Screens, portable, 13

Setting a password, 68

Settings menu, 52, 60 to 61

Sharpness setting, 57

Signal menu, 52, 58 to 60

Sleep mode, 42, 63

Sound, *see* Audio

Source Search button, 33 to 34, 46

Source, selecting, 20, 25 to 28, 33 to 34, 46,
59 to 60

Speaker, specifications, 97

Specifications

brightness, 7, 97

electrical, 98

environmental, 99

lamp, 98

lens, 97

remote control, 98

resolution, 7, 97, 101 to 102

safety, 99

Sports color mode, 41, 56

sRGB color mode, 41, 56

Standby mode, 42, 63

Startup screen

creating, 66 to 67

displaying, 67 to 69

user's logo, *See* User's Logo

- Startup Screen setting, 62
- Status lights, 83 to 84
- Stopping action, 47
- Stripes in image, 91
- Support, 9, 95 to 96
- S-Video button, 46
- S-Video cable, 12, 13, 24
- Switching picture source, 34, 46
- Sync, adjusting, 59, 90 to 91

T

- Technical support, 9, 95 to 96
- Temperature
 - light, 83 to 84
 - requirements, 99
- Theatre color mode, 41, 56
- Timer, lamp, 79 to 80
- Tint setting, 56
- Tracking, adjusting, 59, 90 to 91
- Transporting projector, 80
- Troubleshooting
 - color, 91 to 92
 - cut-off image, 40, 88
 - image quality, 89 to 91
 - image shape, 89
 - no image, 85 to 87
 - no sound, 92
 - password, 93
 - pointer, 94
 - remote control problems, 93 to 94, 105
- Turning off audio, 47
- Turning off picture, 47
- Turning off projector, 42 to 43
- Turning on password, 68 to 69
- Turning on projector, 32 to 33
- Turning on User's Logo, 62, 68 to 69
- Typing the password, 69 to 70

U

- Unpacking projector, 10
- USB mouse cable, 21
- User's Logo
 - creating, 66 to 67
 - displaying, 67 to 69
 - turning on, 62, 68 to 69

V

- VCR, connecting to, 24
- VGA computer cables, 10, 19 to 20
- Video
 - display settings, 64 to 65
 - formats, supported, 7, 100
 - source, connecting to, 24
 - source, selecting, 25, 33 to 34, 46, 59 to 60
- Video button, 46
- Video Signal setting, 60
- Volume, adjusting, 42, 61

W

- Warning lights, 83 to 84
- Warranty, 10
- Weight, 98
- Wireless mouse, 21, 49, 94

Z

- Zoom ratio, 97
- Zooming image, 38, 47 to 48

EPSON[®]
EXCEED YOUR VISION